

## **Appendix 1: Eddystone 'All World Two' Instruction Manual**



# EDDYSTONE

## 'ALL WORLD TWO'

Battery Operated Receiver.



British Made.

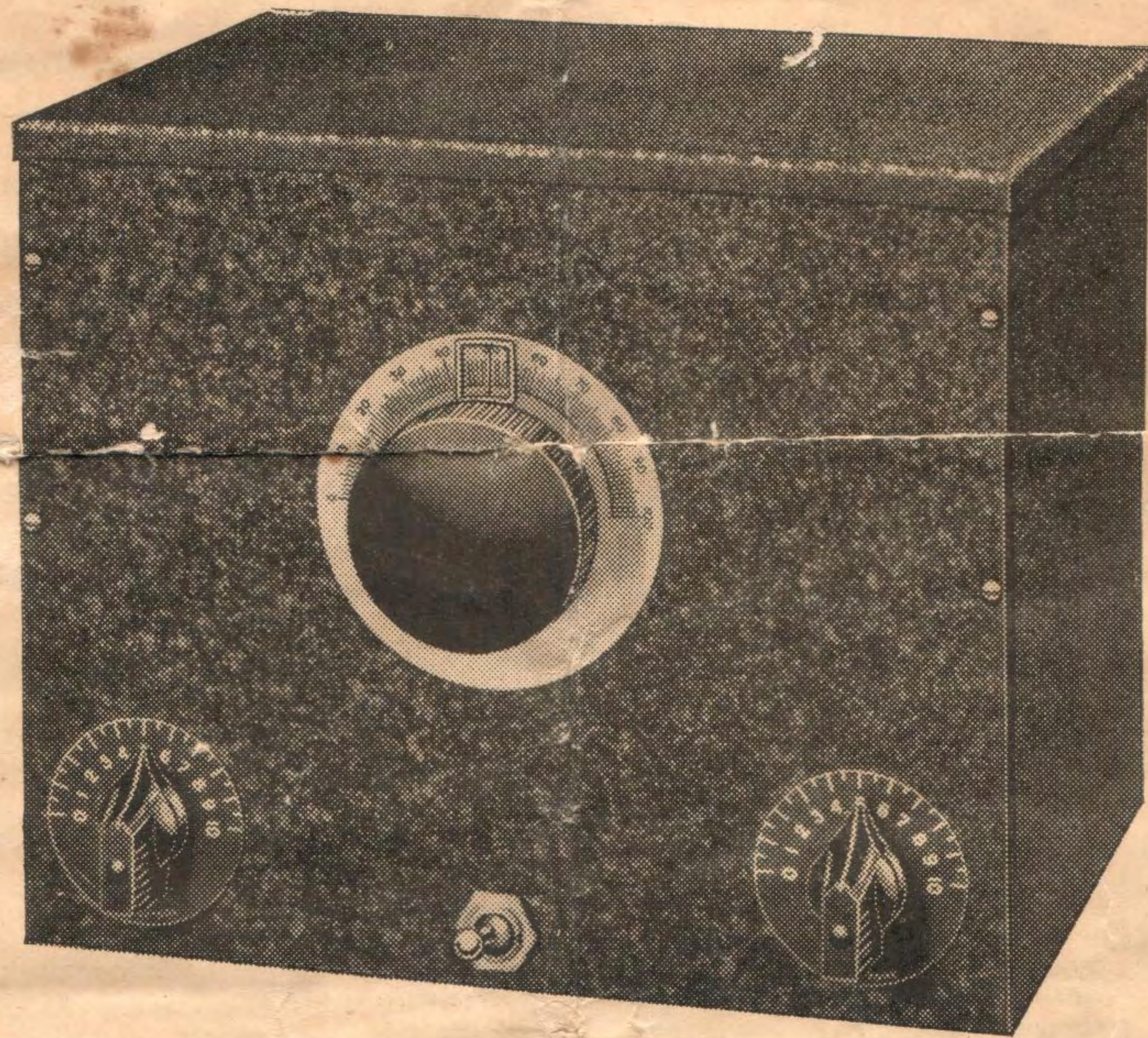

---

---

INSTRUCTION MANUAL FOR  
INSTALLATION & OPERATION

---

---

STRATTON & CO., LTD., EDDYSTONE WORKS, BIRMINGHAM.



The Eddystone All World Two receiver is designed to give World-wide headphone reception with a minimum expenditure. It is the outcome of considerable research and during extensive tests results were highly satisfactory; America, Australia and other long distant stations being consistently received at good volume.

The set is simple to operate and has small current consumption. It is equally suitable for short wave broadcast and amateur band reception since it is fitted with the special Eddystone bandspread tuning unit, which allows continuous bandspreading on all wavebands. The waverange covered by the two coils supplied with the receiver is 15.5 to 52 metres, but if it is wished to receive on intermediate bands between 50 and 200 metres, extra coils are available.

There is a high degree of sensitivity combined with low noise level, and careful design of the aerial input circuit has eliminated tuning blind spots. Constant and smooth reaction has negligible effect on tuning and complete stability of handling is assured. A rigid die-cast chassis houses the component parts and provides ample screening.

The circuit embodies a screened H.F. pentode valve followed by a pentode audio stage. The aerial input circuit, although simple in design, ensures complete freedom from tuning blind spots, thus saving the extra cost of an H.F. stage which is the generally accepted medium for overcoming such trouble. Regeneration is obtained by a modified Reinartz circuit, feedback current being controlled by varying the S.G. voltage with a potentiometer. The high tension battery is suitably isolated to prevent current leakage through the potential divider circuit.

#### CONNECTING UP.

Place the desired coil in the coil base, a Mazda SP210 valve in the first valveholder V1, and an Osram KT2 output valve in V2. Use a set of 2,000 ohm headphones in the 'phone sockets and connect aerial and earth leads. Put the on-off switch in the "off" position (turned left) and connect the 120v. H.T. and 2v. L.T. batteries and aerial-earth wires.

#### OPERATION.

Set tuning dial at  $0^\circ$  and the tank condenser at position 0. Switch on by turning the switch to the right, and advance reaction control until a faint rushing sound is heard in the 'phones, thus denoting oscillation. Stations may now be tuned in. Leaving the tank condenser at 0, turn the tuning dial from 0 to 100 degrees, keeping the set just off oscillation for telephony and weakly oscillating for C.W. signals. Stations will now be heard. Turn tank condenser to No. 1 position and again tune from 0 to 100 degrees, and so on until the whole 10 positions of the tank condenser have been explored. Proceed likewise with other coil.

#### CONTINUOUS BANDSPREADING.

Tuning is accomplished by two parallel condensers. The band required is selected by the large condenser which is variable in ten equal steps only and is named the tank condenser. A small vernier condenser slightly larger in capacity than the capacity difference between the steps on the tank condenser, is used for final tuning.

Suppose the coils were tuned in the normal way with a .00016 mfd. variable condenser. Then the 6LB coil would tune from approximately 19,350 kc/s. at  $0^\circ$  on the dial to 10,100 kc/s. at  $100^\circ$ . Thus, a frequency bandwidth of 9,250 kc/s. is obtained by turning the condenser through 100 degrees on the dial. With the bandspreading system employed in this receiver the band required is selected by putting the tank condenser knob on, say, No. 5 position, and the small tuning condenser then tunes a frequency bandwidth of only 855 kc/s. approximately, as the dial is rotated from 0 to 100 degrees. Since we have only covered a 1/10th of the previous waveband tuning is ten times as easy as with a normally tuned receiver. The tuning condenser has a 9 : 1 slow motion head incorporated in its movement, and by this tuning difficulties are still further decreased.

To give the user an idea of how the various bands are "spread" the curves shown overleaf were taken on a specimen receiver. These show the effect of bandspreading, the numbers on the curves indicating the position of the



EDDYSTONE "ALL WORLD TWO"

pointer knob on the tank condenser, while the figures on the horizontal line refer to the degrees on the tuning condenser dial.

It will be seen that the 14 megacycle amateur band is "spread" over 40 degrees on the 6LB coils, while the 6Y coil brings in the 7 megacycle band over 80 degrees on the dial. These figures show why this receiver is equally useful for amateur reception. The overlaps between the various settings of the tank condenser have been arranged so that no stations will be missed.

It should be noted that the curves shown are for an average receiver and are to give the listener some knowledge of the wavelengths covered by each position of the tank condenser. Individual receivers will vary somewhat, due to different valve and circuit capacities. The effect of aerial load, although minimised in this receiver, will influence the wavelengths covered to a small degree.

COIL 6LB.

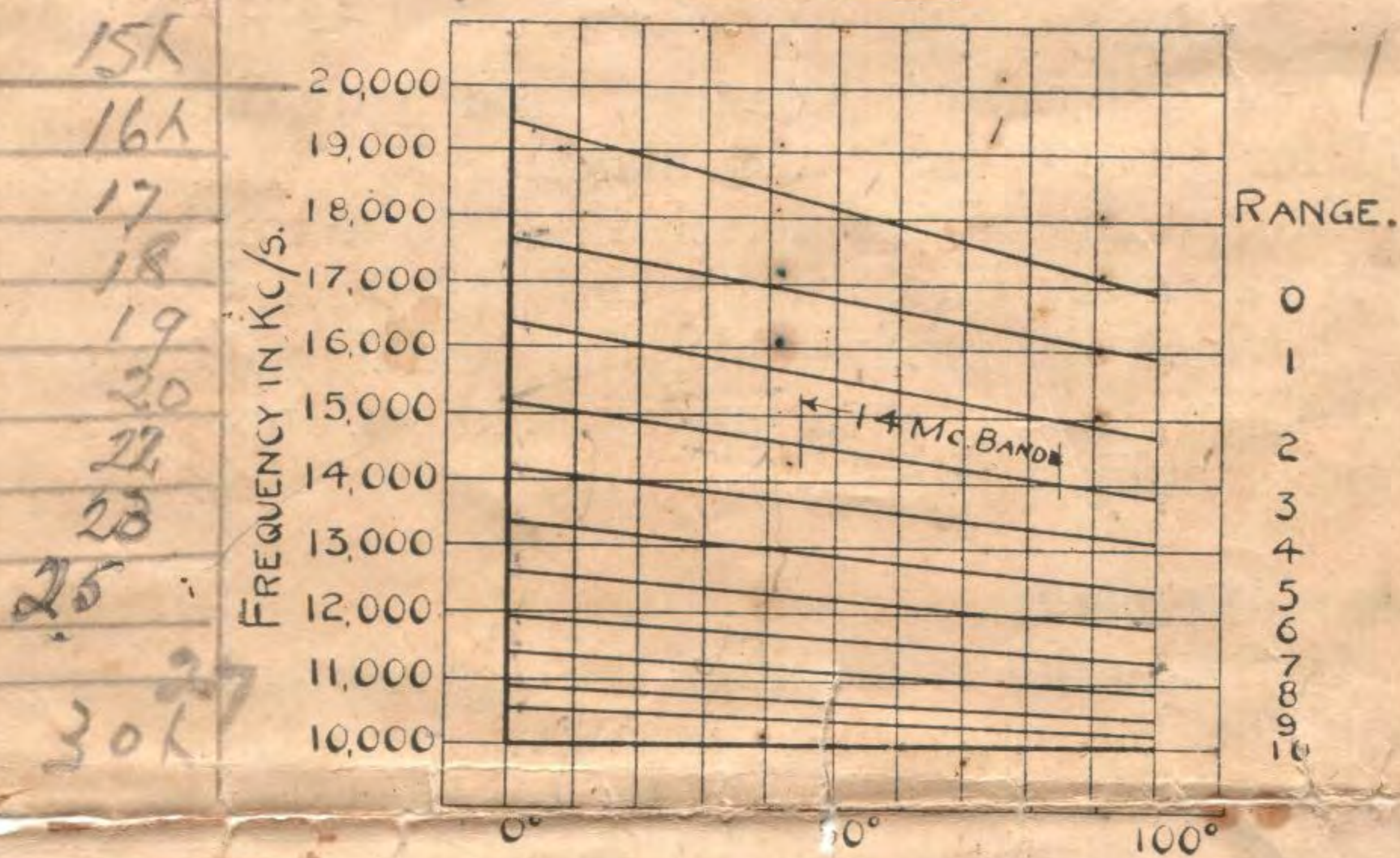

TUNING CONDENSER SCALE.

Waverange: 19,350 Kc/s - 10,100 Kc/s.  
(15.5m. - 29.7m.)

COIL 6Y.

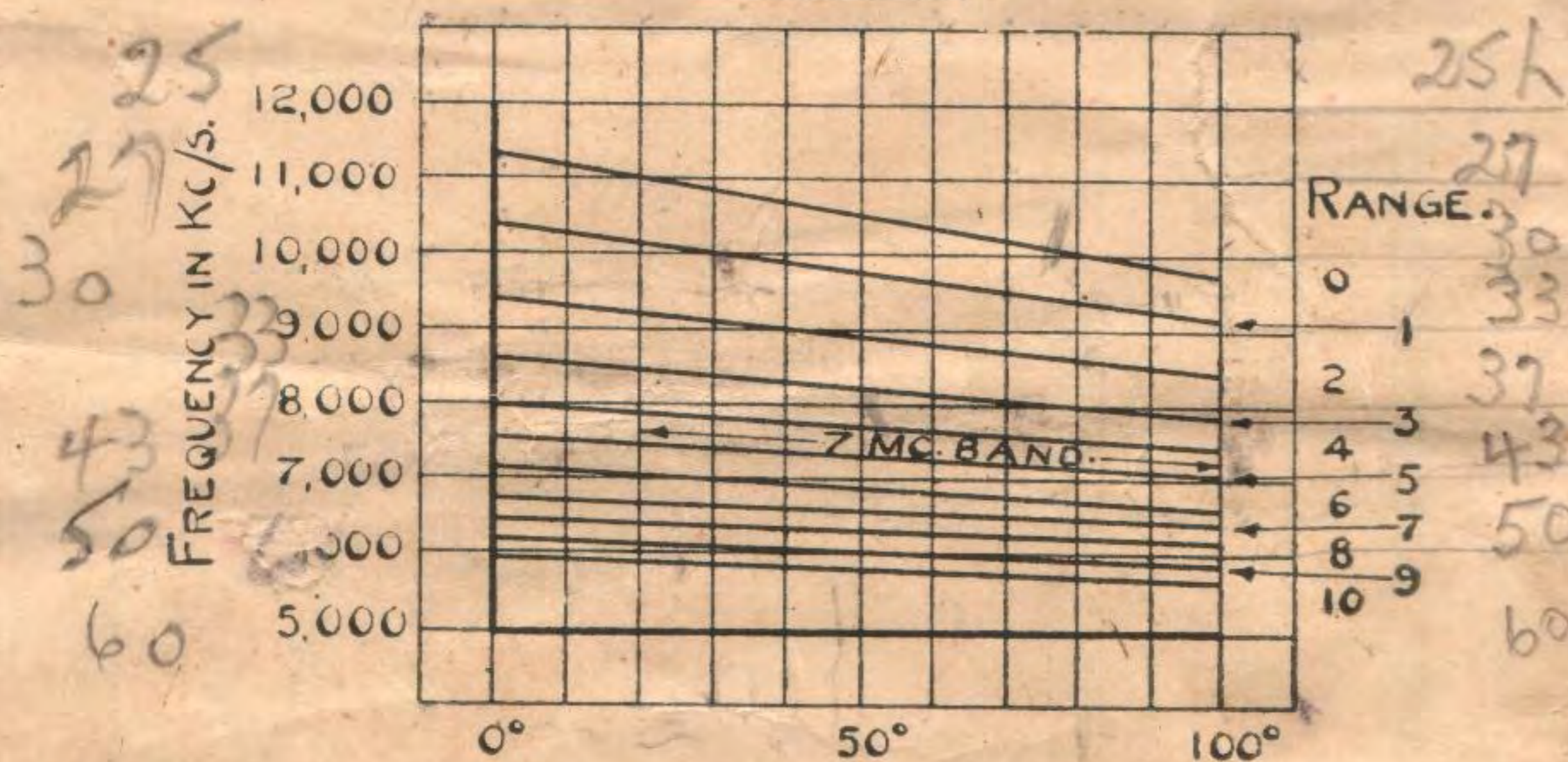

TUNING CONDENSER SCALE.

Waverange: 11,350 Kc/s - 5,690 Kc/s.  
(26.45m. - 52.7 m.)

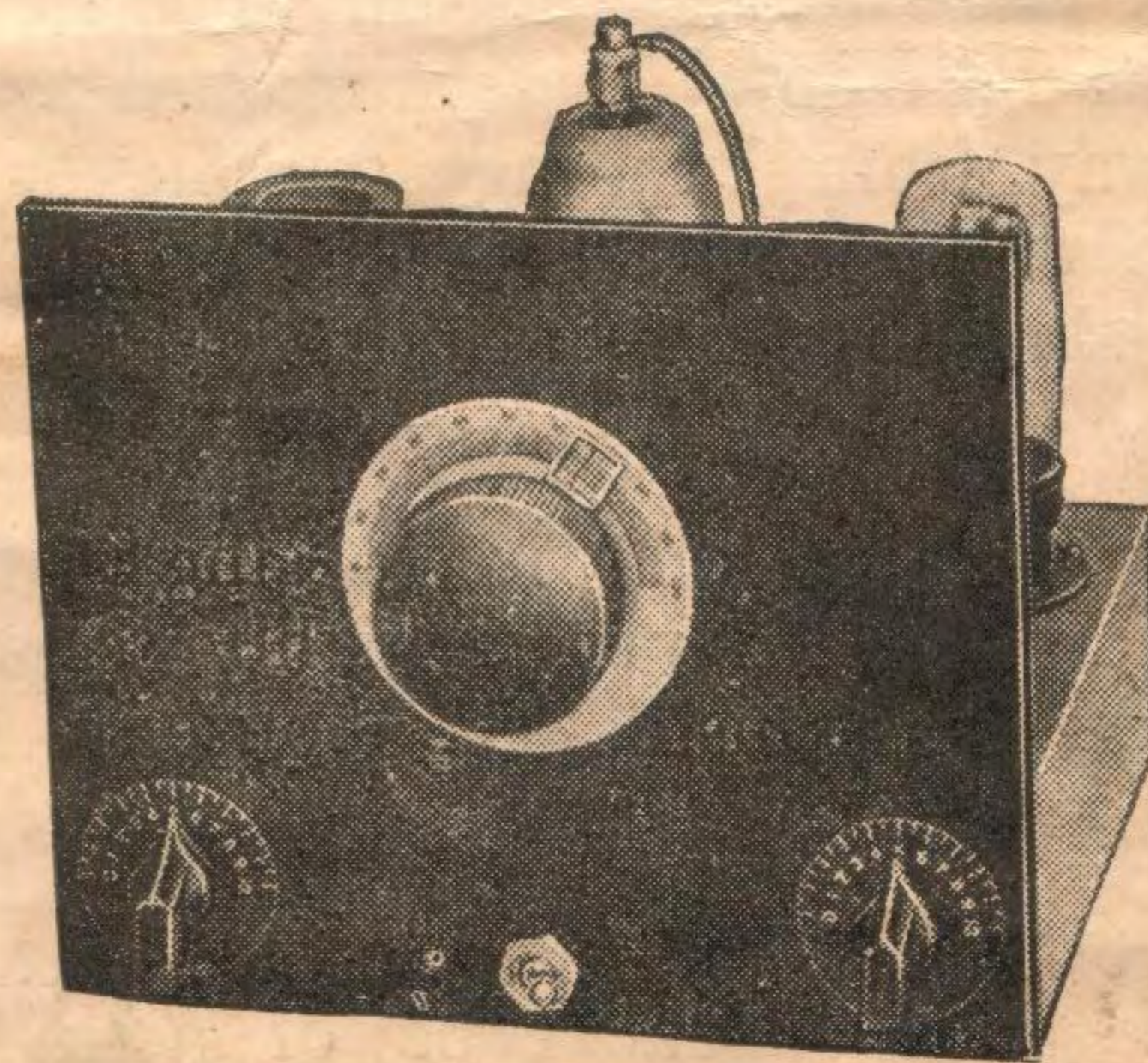

TANK CONDENSER ON-OFF SWITCH REACTION CONTROL



PHONES EARTH AERIAL

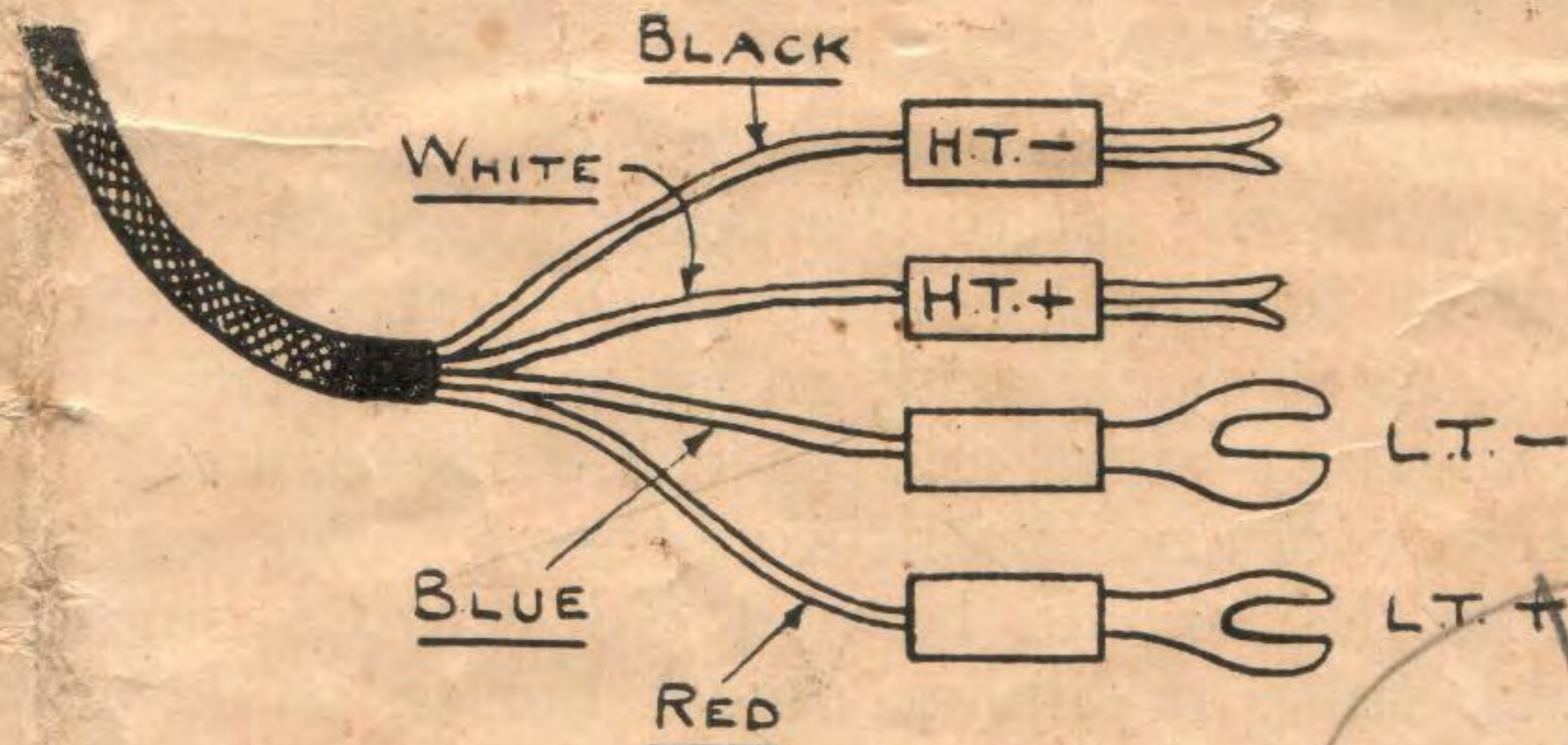

BATTERY CONNECTIONS.

Handwritten circled number: 687

Handwritten notes: 39, 34A, 74, 3CR, 7



## THE AERIAL AND EARTH.

The qualifications of a good aerial are firstly, that it shall be in as open a position as possible, that is, not badly screened by nearby objects, such as trees or buildings. Secondly, that it shall be as high as convenient, at least 30 ft. ; and thirdly, it should be well insulated and in one piece without any frayed strands, right to the lead-in. The down wire from the horizontal section should always be well away from buildings and never carried down a wall. Inside the house, the lead to the set should be direct and short.

For the outside wire, a single strand of 14g. enamelled copper is highly satisfactory, while the lead inside the house to the set should be insulated flex.

The most usual type of aerial is the inverted L type shown in diagram A.

**Length of Aerial.**

An all round standard to work to for good short wave reception is about 50 ft. of wire from the free end of the aerial to the set.

To obtain maximum selectivity, a length of wire down to as low as 20 ft. can be employed. If atmospherics cause considerable interference, a shorter aerial is to be preferred to a longer one. For short wave reception, the aerial can be of any length between 20 ft. and 60 ft. There is usually a loss of volume below 40 ft.

**The Earth.**

The earth lead should consist of insulated wire from the set to the point where the connection to earth is made. Do not use bare wire, as it may result in premature earthing to walls or pipes and so cause noises in the receiver or indifferent reception. The earth connection should be well soldered to a copper earth tube or similar object buried in damp ground. It is important that the length of the earth connection is kept as short as possible. A good earth is always desirable.

**Notes on Aerial Erection.**

See that the aerial does not sway unduly, on the other hand, it is not necessary to have it ultra taut.

Arrange so that it can be let down at least from one end for an occasional inspection.

When pulleys are used for hoisting and letting down, see that they are of the type in which the rope or wire cannot slip out of the pulley groove and jam.

Covered stranded steel wire, such as Electron aerial wire or Superaerial, makes good hoisting and supporting wire for the aerial proper.

Well galvanized stranded iron wire is good for guying poles and masts.

Do not fasten the aerial direct to a tree which can sway in a wind. Unless left very loose, which is inadvisable, the aerial will break. In this case a pulley and balance weight should be used.

**General Remarks.**

If the aerial is sloping, the highest end should be the one which is away from the receiver. The down lead should be taken from the horizontal section immediately in front of the insulator and not from a short distance along the wire. The best method of obtaining a down lead is to continue the main aerial by securely twisting it at the insulator and so avoiding the necessity of making a soldered joint.

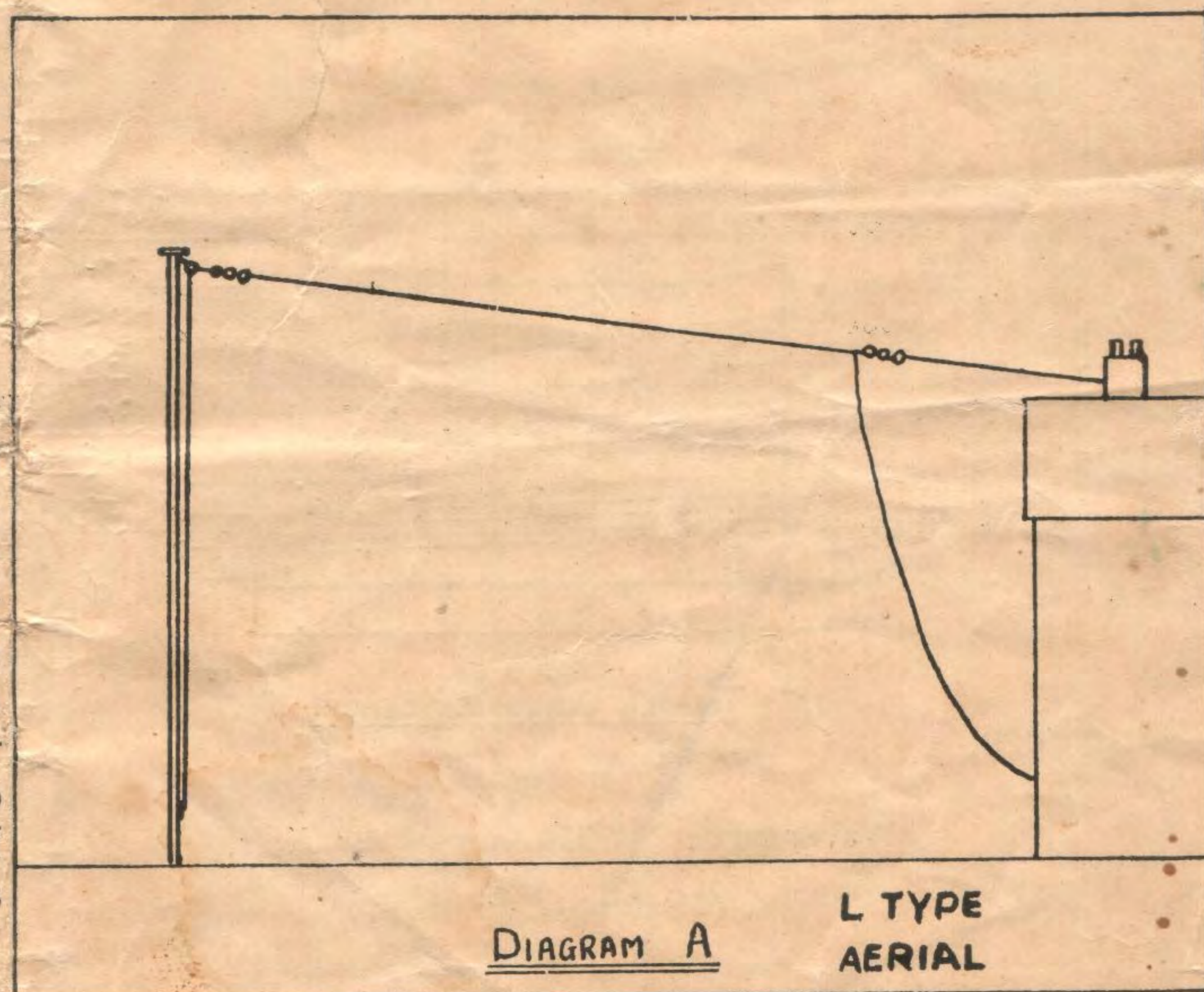



**Appendix 2: Extracts from *Eddystone Short Wave Manual Issue 3*  
(AW2 Construction and High Frequency Amplifier/Short Wave  
Converter articles)**



# THE ALL WORLD TWO

15.5 TO 52 METRES.

A POWERFUL 2 VALVE SHORT WAVE BATTERY RECEIVER  
WITH BANDSPREAD TUNING.

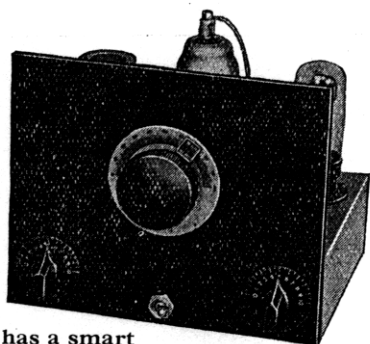

The set has a smart front appearance—

The Eddystone All World Two receiver is designed to give adequate world wide head-phone reception with a minimum expenditure. It is the outcome of considerable research in our laboratory and during extensive tests results were highly satisfactory; America, Australia and other long distant stations being consistently received with good volume and quality.

The set is inexpensive and easy to build; simple to operate and has small current consumption. It is equally suitable for short wave broadcast or amateur band reception since it is fitted with the special Eddystone Bandspread Tuning unit, which allows continuous bandspreading on all wavebands. The waverange covered by the two coils supplied with the receiver is 15 to 52 metres, but if it is wished to receive on intermediate bands between 50 and 200 metres, extra coils are available and no structural or wiring alterations necessary.

There is a high degree of sensitivity combined with low noise level, and careful design of the aerial input circuit has completely eliminated tuning blind spots. Constant and smooth reaction has negligible effect on tuning and complete stability of handling is assured. A rigid die-cast chassis houses the component parts and provides ample screening.

The theoretical circuit embodies a screened H.F. Pentode valve followed by an audio stage which can use either triode or pentode valve as desired. The aerial input circuit, although simple in design, was only satisfactorily developed after protracted experiments on many different types of aerials.

It ensures complete freedom from tuning blind spots, thus saving the extra cost of an H.F. stage which is the generally accepted medium for overcoming such trouble. Regeneration is obtained by a modified Reinartz circuit, feedback current being controlled by varying the S.G. voltage with a potentiometer. The high tension battery is suitably isolated to prevent current leakage through the potential divider circuit.

## CONSTRUCTION.

Proceed as follows:

The sockets for the aerial and earth and 'phone strips should be mounted and the strips finally screwed on the back of the chassis by the  $\frac{1}{4}$ " 6BA roundhead screws provided.

All holes in the chassis marked "E" on the practical wiring diagram *must* be carefully scraped above and below the chassis as earth connections are made at these points.

Mount the 1+1 mfd. condenser on the front of the chassis with countersunk screws, and fix the two valveholders and coil base in position. Do not forget the soldering tags "E" under some of the fixing screws.

The reaction trimmer is now mounted in its appropriate fixing holes. The reaction potentiometer, on-off switch and tank condenser should be assembled on the chassis, the panel and 0-10 scales fitted, and the panel held in position by the switch, condenser and potentiometer fixing nuts.

To ensure absolutely noiseless reaction control the specified variable potentiometer should be used.



and a tidy, attractive chassis lay out.



ALL WORLD TWO—continued

The tank condenser spindle should be turned until the moving plates are fully out of mesh with the fixed plates and the pointer knob fixed opposite the 0 division on the scale by screwing up the small grub screw. By turning the knob clockwise, the condenser will rotate in 10 steps up to the maximum capacity.

Turn the reaction spindle as far anti-clockwise as it will go, and fix the pointer knob so that the pointer is placed at the position which the small hand of a clock points to at eight o'clock.

It is advisable to leave the tuning condenser off the panel until all the wiring is finished. This enables the chassis to be mounted upside down on the edge of a table to facilitate wiring. Wires Nos. 9 and 10 may be connected at one end, but the free ends left until the rest of the wiring is completed.

Certain condenser and resistances not already assembled are automatically supported by their connections, so the wiring may now be commenced, and should be carried out without difficulty with the aid of the wiring plan on centre pages and point to point connection list on pages 4 and 5 overleaf.

RESISTANCE COLOUR CODE.

Resistance	Body	Tip	Dot
40,000 ohms	Yellow	Black	Orange
100,000 ohms	Brown	Black	Yellow
1 meg. ohms	Brown	Black	Green
3 meg. ohms	Orange	Black	Green
1,000 ohms	Brown	Black	Red

VALVES.

The kit has been designed around the Mullard SP2 Screened Grid and Mazda P220 Triode valves. The constructor may use any of the two other triode valves specified or alternatively one of the three pentode valves listed below.

The average total number of milliamps for any of the pentodes or triodes are given in the right-hand column below, from which it will be seen that the use of the pentode type of output does not increase the consumption of the receiver, but does in practice considerably add to the signal strength.

A five-pin valveholder is fitted in the output stage, the centre pin automatically connecting the auxiliary grid to the H.T. supply when a pentode is used.

An automatic bias resistance is incorporated in this receiver, and it has been calculated to be equally suitable for the following output valves :

(a)	(b)	Total Milliamps with Detector Valve	
TRIODE VALVE (7/-)	PENTODE VALVE (13/6)	(a)	(b)
Mazda P220	Mazda Pen. 220	4.5	4.8
Osram LP2	Osram PT2	4.55	5.1
Mullard PM2A	Mullard PM22A	4.55	3.95

CONNECTING UP.

Place the desired Coil in the coil base, a Mullard SP2 Valve in the first valveholder V1, and the appropriate Output Valve in V2. Use a pair of 2,000 ohm headphones in the 'phone sockets and connect aerial and earth leads. Put the on-off switch in the "off" position (turned left) and connect up the H.T. and L.T. batteries.

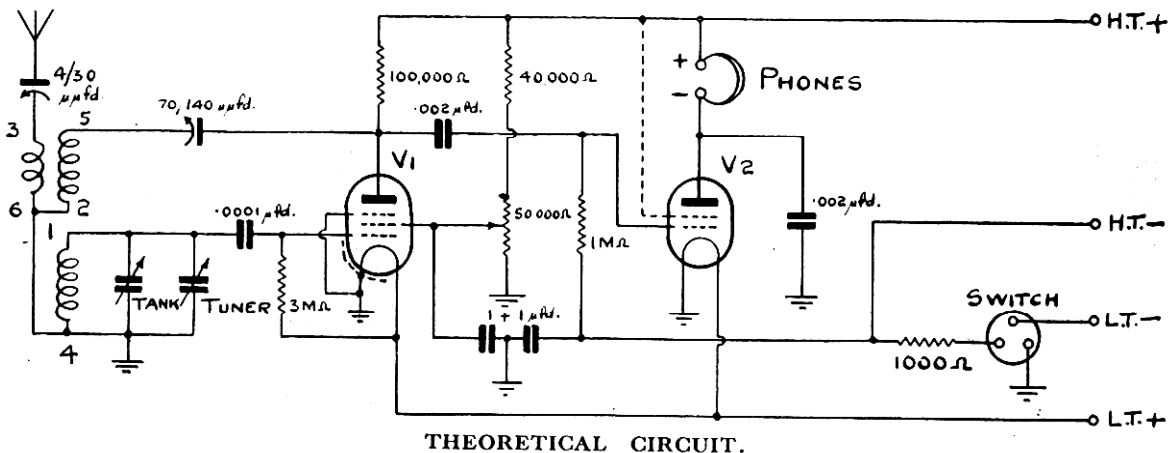

THEORETICAL CIRCUIT.



# ALL WORLD TWO

## WIRING PLAN UNDER CHASSIS

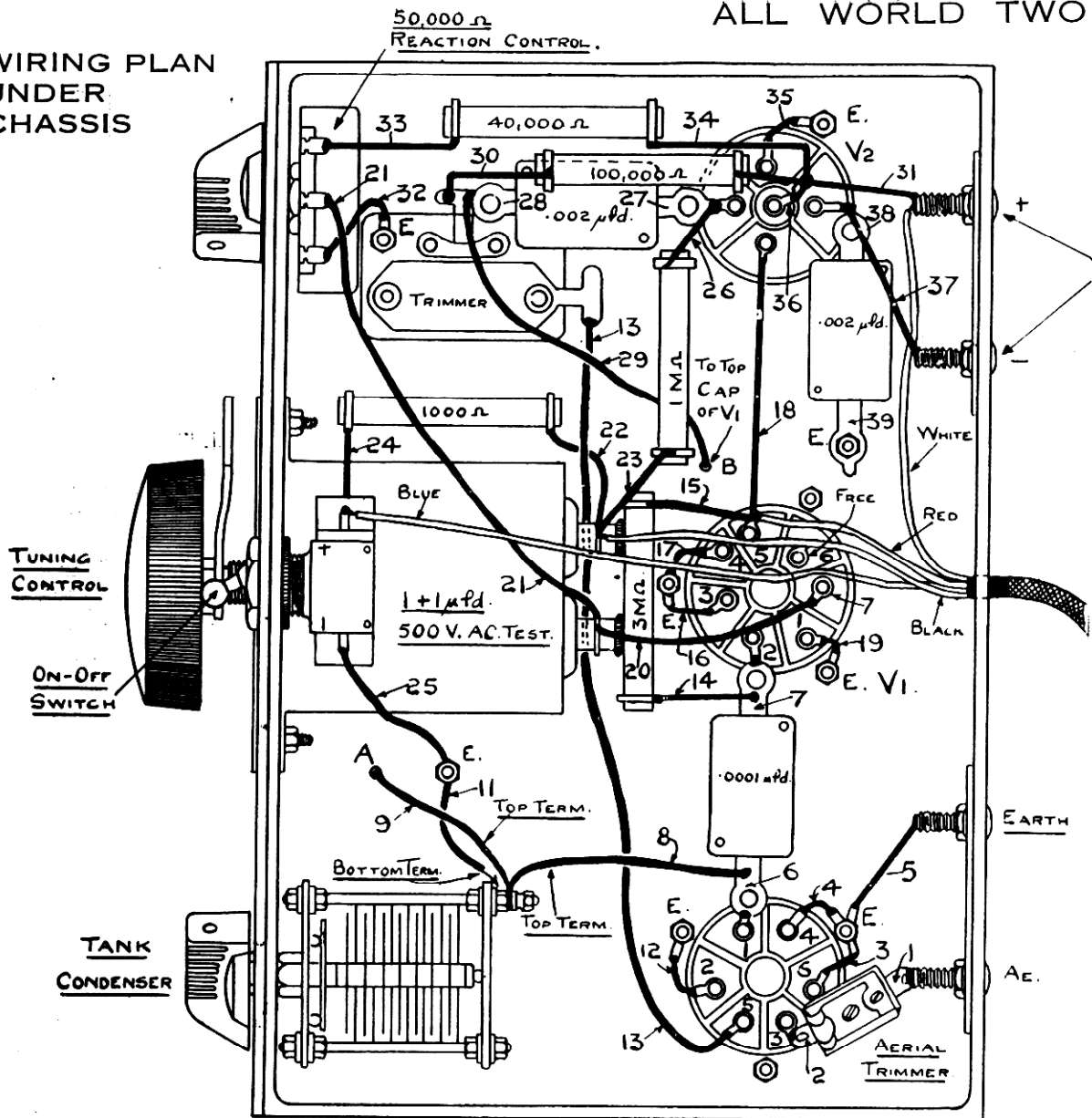

### POINT TO POINT CONNECTIONS.

The following Point to Point Connections are necessary:

- \*1—One end of Aerial Trimmer to Aerial Socket.
- \*2—Other end of Aerial Trimmer to Socket No. 3 on Coil Base.
- 3—Socket No. 6 of Coil Base to Soldering Tag E.
- 4—Socket No. 4 of Coil Base to Soldering Tag E.
- 5—Earth Socket to Soldering Tag E.
- \*6—One end of .0001 mfd. Condenser to Socket No. 1 on Coil Base.
- \*7—Other end of this Condenser to Socket No. 2 on Valveholder V1.
- 8—End of .0001 mfd. Condenser to Top Terminal (Fixed Plates) of Tank Condenser.
- 9—Top Terminal of Tank Condenser, through hole A in Chassis, to Fixed Plates of Tuning Condenser.
- 10—Moving Plates of Tuning Condenser to Soldering Tag E.
- 11—Bottom Terminal (Moving Plates) of Tank Condenser to Soldering Tag E.
- 12—Socket No. 2 of Coil Base to Soldering Tag E.
- 13—Socket No. 5 of Coil Base to Reaction Trimmer.

- \*14—One end of 3 megohm Leak to Socket No. 2 of V1.
- \*15—Other end of Leak to Socket No. 5 of V1.
- 16—Socket No. 3 of V1 to Soldering Tag E.
- 17—Socket No. 4 of V1 to Soldering Tag E.
- 18—Socket No. 5 of V1 to Filament Socket of Valveholder V2. Socket No. 6 is left free.
- 19—Socket No. 1 of V1 to Soldering Tag E.
- 20—Socket No. 7 of V1 to One Terminal of 1+1 mfd. Condenser.
- 21—Same Terminal of Condenser Block to Middle Tag of Reaction Control.
- \*22—One end of 1000 ohm Resistance to other Terminal of Condenser Block.
- \*23—1 megohm Leak to Terminal of Condenser Block.
- \*24—Remaining end of 1000 ohm Resistance to Bottom Tag of On-Off Switch.
- 25—Tag of On-Off Switch to Soldering Tag E.
- \*26—Remaining end of 1 megohm Leak to Grid Socket of V2.



WIRING  
PLAN—  
CHASSIS  
TOP

PHONES

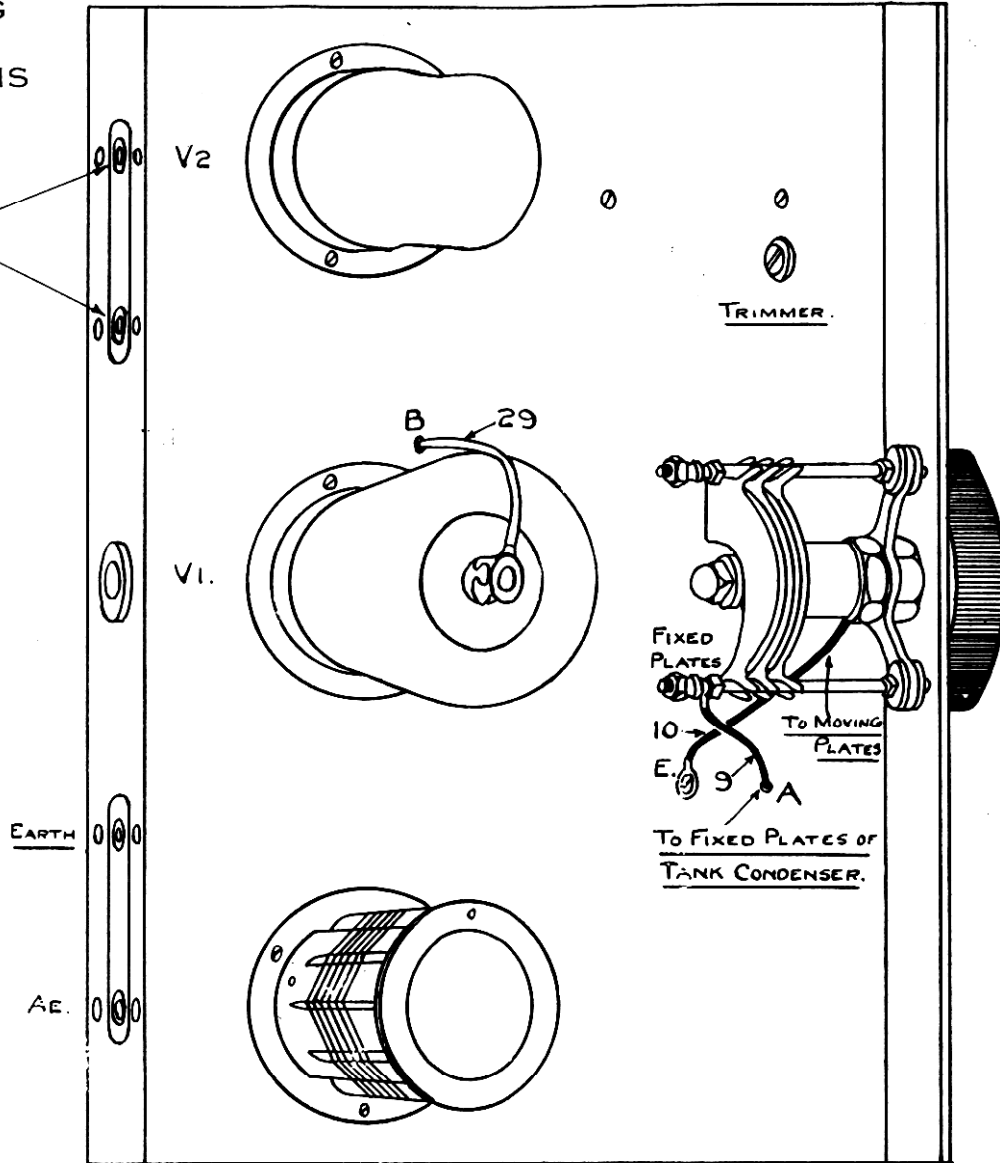

ALL WORLD TWO

Point to Point Connections—cont'd.

- \*27 One end of .002 mfd. Condenser to Grid Socket of V2.
  - \*28 Other end of this Condenser to Reaction Trimmer.
  - \*29 Same Connection of Trimmer, through B in chassis, to Top Cap of V1.
  - \*30 One end of 100,000 ohms Resistance to same Side of Trimmer.
  - \*31 Other end of 100,000 ohms Resistance to + Phone Socket.
  - \*32 End Tag of Reaction Control to Soldering Tag E.
  - \*33 Tag of Reaction Control to 40,000 ohms Resistance.
  - \*34 Remaining end of 40,000 ohms Resistance to Connection No. 31.
  - \*35 Filament Socket of V2 to Soldering Tag E.
  - \*36 Centre Socket of V2 to Connection No. 31.
  - \*37 Anode Socket of V2 to - Phone Socket.
  - \*38 One end of .002 mfd. Condenser to Anode Socket of V2.
  - \*39 Other end of .002 mfd. Condenser to Boss E.
- \*No wire is necessary on these connections as contact is automatically made by the tags or wire ends of the components concerned.

BATTERY LEADS.

The end of the battery cable should be stripped of its braiding for about 6 inches and the leads placed through the hole in the back of chassis and wired up as follows:—

- L.T.+ (Red) to No. 5 Socket of V1.
- L.T.- (Blue) to Top Tag of On-Off Switch.
- H.T.+ (White) to + Phone Socket.
- H.T.- (Black) to Condenser Block.

The end of the braiding may be bound with twine to make a neat ending.



## ALL WORLD TWO—continued OPERATION.

Unscrew aerial trimmer to nearly minimum capacity and put tuning dial at 0° and the tank condenser at position 0. Switch on by turning the switch to the right, and adjust reaction trimmer until a faint rushing sound is heard in the phones when the reaction control is turned three-quarters of the way clockwise. It will generally be found that the reaction trimmer has to be screwed fully clockwise for correct oscillation. Stations may now be tuned in. Leaving the tank condenser at 0, turn the tuning dial from 0 to 100 degrees, keeping the set just off the verge of oscillation for telephony and weakly oscillating for C.W. signals. Stations will now be heard. Turn tank condenser to No. 1 position and again tune from 0 to 100 degrees, and so on until the whole 10 positions of the tank condenser have been explored. *The receiver should not be calibrated until the optimum setting of the aerial trimmer has been found.* Proceed likewise with other coil.

For the best results with any aerial, the aerial trimmer screw should be turned half a turn clockwise at a time until a blind spot is found on one of the two coils. Then reduce the setting of this condenser until the blind spot disappears. This position will give maximum selectivity and sensitivity. *In short, use as much capacity as possible for the aerial trimmer, consistent with freedom from blind spots.* The set may now be calibrated, but the aerial trimmer should not be re-adjusted again since this would alter calibrations.

To achieve maximum efficiency however, a larger value condenser (our Catalogue No. 1013 being quite suitable) may be used in place of the aerial trimmer. Blind spots may be present but can usually be moved to a part of the band which does not matter. If this alteration is made the wave range charts on page 7 will not apply.

If no signals are heard, check the receiver with a milliammeter and a voltmeter. The following voltages and currents should obtain with 115 volt H.T. supply :

### SP2—

Anode Current (approx.) 0.25 m.a.  
Anode Voltage 90 volts.

### P220—

Anode Current 3 m.a.  
Anode Voltage 115 volts.

Potentiometer Current 1.25 m.a.

Total Current 4.5 m.a. at 115 volts.

These figures are for an average kit and will vary slightly for individual receivers.

## CONTINUOUS BANDSPREADING.

Tuning is accomplished by means of two parallel condensers. The band required is selected by the large condenser which is variable in ten equal steps only and is called the tank condenser. A small vernier condenser slightly larger in capacity than the capacity difference between the steps on the tank condenser, is used for final tuning.

Suppose the coils were tuned in the normal way with a .00016 mfd. variable condenser. Then the 6LB coil would tune from approximately 19,350 kc/s. at 0° on the dial to 10,100 kc/s. at 100°. Thus, a frequency bandwidth of 9,250 kc/s. is obtained by turning the condenser through 100 degrees on the dial. With the bandspreading system employed in this receiver the band required is selected by putting the tank condenser knob on, say, No. 5 position, and the small tuning condenser then tunes a frequency bandwidth of only 855 kc/s. approximately, as the dial is rotated from 0 to 100 degrees. Since we have only covered a 1/10th of the previous waveband tuning is ten times as easy as with a normally tuned receiver. As the tuning condenser has a 9:1 slow motion head incorporated in its movement, it will be appreciated that tuning difficulties are still further decreased.

To give the constructor an idea of how the various bands are "spread" the curves on page 7 were taken on a specimen receiver. These show the effect of bandspreading, the numbers on the curves indicating the position of the pointer knob on the tank condenser, while the figures on the horizontal line refer to the degrees on the tuning condenser dial.

It will be seen that the 14 megacycle amateur band is "spread" over 40 degrees on the 6LB coils, while the 6Y coil brings in the 7 megacycle band over 80 degrees on the dial. These figures clearly show why this receiver is suitable for amateur reception. The overlaps between the various settings of the tank condenser have been designed so that no stations will be missed.



ALL WORLD TWO—continued

COIL 6LB.

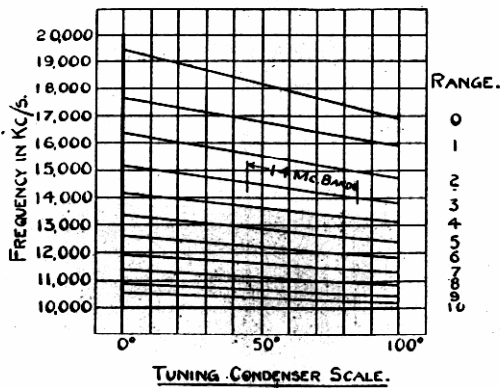

Waverange: 19,350 Kc/s - 10,100 Kc/s.  
(1.5m.—29.7m.)

COIL 6Y.

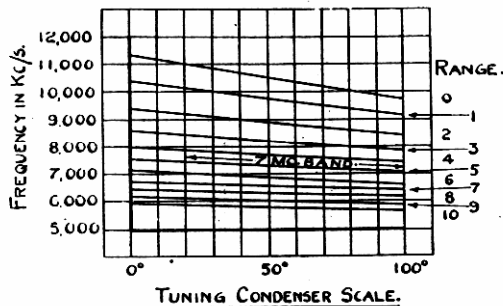

Waverange: 11,350 Kc/s—5,650 Kc/s.  
(26.45m.—52.7 m.)

NOTE :

It must be emphasised that the curves shown are for an average receiver and are drawn to give the listener some knowledge of the wavelengths covered by each position of the tank condenser. Individual receivers will vary somewhat, due to different valve and circuit capacities, and the effect of aerial load, although minimised in this receiver, will influence the wavelengths covered to a small degree.

AS S.W. ADAPTOR.

This receiver provides an efficient alternative to the super-het type of short wave converter. Its output can easily be connected to the pickup terminals of a broadcast receiver by a 1-1 transformer.

EDDYSTONE PARTS.

	Price
1 6-pin Low Loss Coil, type 6LB .. ..	4/-
1 6-pin Low Loss Coil, type 6Y .. ..	4/-
1 Patented Tank Condenser with Knob and Graduated Dial Plate, Cat. No. 1042	6/-
1 Bandsread Condenser Unit with Slow Motion Head, Knob, Dial and Cursor, Cat. No. 1043 .. ..	6/6
1 Short Wave Mica Trimmer Condenser, Cat. No. 1023 .. ..	1/-
1 Low Loss Valveholder, Cat. No. 954 ..	1/-
1 Low Loss Valveholder, Cat. No. 964 ..	1/3
1 Low Loss Valveholder, Cat. No. 985 ..	1/4
1 1 x 1 mfd. Fixed Condenser .. ..	4/-
1 Aluminium Die-Cast Chassis, drilled all necessary holes, finished inside and out battleship grey cellulose ..	12/9
1 Burr Walnut Bakelite Panel, drilled necessary holes .. ..	2/9
2 Bakelite Terminal Panels .. ..	6d.
1 Scale and Pointer Knob, 1 1/4" dial ..	1/-
1 Special 50,000 ohm Variable Potentiometer	5/-
1 Welded Steel Cabinet, finished dark crystalline brown, Cat. No. 1061 ..	9/6

MISCELLANEOUS PARTS.

1 70/140 m.mfd. Trimmer Condenser ..	
1 3-point Switch .. ..	
2 Dubilier Condensers, .002 mfd. ..	
1 Dubilier Condenser, .0001 mfd. ..	
1 Erie Resistor, 1,000 ohms, 1 watt ..	
1 Erie Resistor, 40,000 ohms, 1 watt ..	
1 Erie Resistor, 100,000 ohms, 1 watt ..	
1 Erie Resistor, 3 megohm, 1 watt ..	
1 Erie Resistor, 1 megohm, 1 watt ..	
Length 4-way Cable .. ..	
4 Clix Parallel Plugs and Sockets (2 red and 2 black) .. ..	
1 pair Clix Spades, red and black ..	
1 pair Clix Wander Plugs, red and black	
Valves. Mullard SP2 .. ..	
Output valve as detailed in instructions (Triode or Pentode).	
Connecting Wire, Screws, Tags, Nuts, Thimble Clip, etc. .. ..	
Approximate Total Cost of Complete Kit, 67/6 (less valves).	

ADDITION OF H.F. AMPLIFIER.

The performance of the All World Two can at any time be extended by the use of the H.F. amplifier unit described on page 34. In this case the output of the amplifier should be connected to end 1 of the grid coil in the All World Two. If a common battery supply is used, note special remarks in H.F. amplifier article, otherwise automatic G.B. of All World Two will be shorted.



# ONE VALVE SHORT WAVE HIGH FREQUENCY AMPLIFIER OR SHORT WAVE CONVERTER.

## BATTERY MODEL.

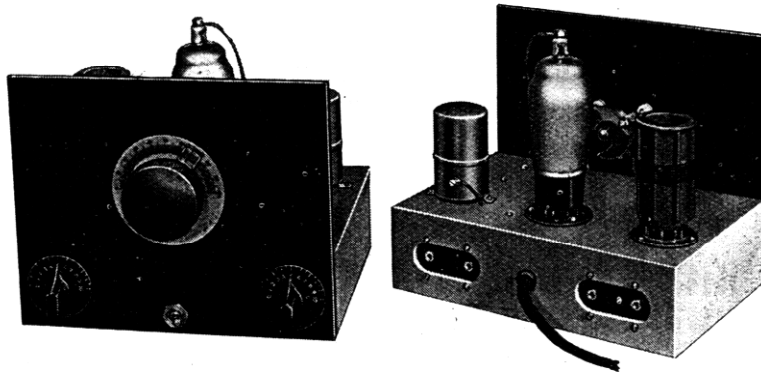

Showing panel and chassis views of this neat assembly.  
Models for either battery or A.C. mains use are described.

This simple and inexpensive unit can be used in two important ways. With an existing broadcast receiver it can be employed as a short wave converter for obtaining reception of short wave signals; secondly, with an all-wave set or a specially designed short wave receiver it can be used in front of either as an additional high frequency amplifier with considerable gain in performance and selectivity.

The unit is simple to build and no change of construction is necessary for use in either form. If, therefore, it is used at first as a converter it need not be scrapped if an all wave set is later purchased, but can be used in front of this as a high frequency amplifier.

The unit is built on a die-cast chassis with metal panel which makes up into an attractive assembly. A smart metal container cabinet is also available, if required. The circuit includes a screened grid high frequency pentode valve with associated coil and tuning condenser. The wave length of 13.75—99 metres is covered by three interchangeable coils as follows: Range 1, 13.75—26.5; Range 2, 25.0—51.8; Range 3, 49.0—99.0. This method is highly efficient since there are no switch losses and the tuning capacity is small.

The circuit, when the unit is used as a converter, becomes an electron coupled oscillator, and since a battery valve has no independent cathode as in the A.C. type, the special iron cored filament choke, Cat. No. 1062, must be used. Oscillation is controlled by a 50,000 ohm potentiometer. When using the set as an H.F. amplifier, naturally the valve is never used in an oscillating condition, and this control is used to obtain regeneration with greatly improved results. Another feature of the unit is the Eddystone patented Bandsread Tuning device, which greatly facilitates the ease of tuning and general operation of the set.

## BATTERY SUPPLY AND CONNECTIONS.

A separate set of batteries or the existing batteries of the broadcast set may be utilised. In this latter case, however, it will not be necessary to connect leads L.T. neg. or H.T. neg. to the batteries as these connections will be made automatically by the earth connection to the receiver. Therefore, join L.T. + and H.T. + only. If common batteries are used the switch on the unit will be inoperative.











## ONE VALVE SHORT WAVE H.F. AMPLIFIER—continued

receiver ; then the two sets of controls should be worked in step. As before mentioned, the 50,000 ohm potentiometer control is used for regeneration.

## OPERATION AS SHORT WAVE CONVERTER.

In this case the existing broadcast receiver should be tuned to a silent part of the wave-band above 1,000 metres. The converter unit is then made to oscillate by the potentiometer control, and the whole of the tuning is carried out on the controls of the converter unit. The actual wave range at the station that is received will be that at which the unit itself is functioning.

## A.C. MODEL.

The use and application of the battery unit described, covers the A.C. model in full. The circuit is slightly modified to take an A.C. valve. It will be noted, however, that the A.C. unit incorporates a filament heating transformer and no H.T. supply. This is done because the necessary rectifier valve and consequent smoothing and transformer arrangements are unnecessarily expensive when H.T. supply sufficient for the one valve in use can easily be obtained from the broadcast receiver. The H.T. lead on the unit should be taken to a point on the receiver where a voltage of 120—150 volts is obtainable. A convenient point of tapping is usually at the speaker or output valve of the main receiver.

## EDDYSTONE PARTS.

## A.C. Model.

	Price
1 Tank Condenser with Knob and Graduated Dial Plate, Cat. No. 1042 .. ..	6/-
1 Bandsread Condenser Unit with Slow Motion Head, Knob, Dial and Cursor, Cat. No. 1043 .. ..	6/6
1 Screened H.F. Choke, Cat. No. 982 .. ..	5/-
1 Pointer Knob and Dial, Cat. No. 1044 .. ..	1/-
1 Base, 6-pin, Cat. No. 964 .. ..	1/3
1 Valveholder, 7-pin, Cat. No. 985 .. ..	1/4
1 Filament Transformer, 220/240 volts, A.C.	10/6
1 Aluminium Die-Cast Chassis, drilled all necessary holes, finished inside and out battleship grey cellulose, Cat. No. 1057 .. ..	12/9
2 Terminal Panels, drilled, with Plugs and Sockets at 9d. each complete .. ..	1/6
1 Metal Panel, finished dark Crystalline Brown, Cat. No. 1058 .. ..	2/9
1 Set Special 6-pin Coils, Cat. No. 1065, Set of 3 coils .. ..	12/-
1 Metal Cabinet, finished Dark Crystalline Brown, Cat. No. 1061 .. ..	9/6
Total, £3 10s. 1d.	

## MISCELLANEOUS PARTS.

3 T.C.C. .1 mfd. Tubular Condensers with wire ends .. ..	
1 Dubilier .0001 mfd. Condenser, type 670 .. ..	
2 Dubilier .002 mfd. Condensers, type 670 .. ..	
1 Dubilier 150 ohm 1 watt Resistor .. ..	
1 Erie 50,000 ohm Potentiometer .. ..	
1 Erie 20,000 ohm 1 watt Resistor .. ..	
1 3 point On-Off Switch .. ..	
24 $\frac{1}{2}$ " x 6BA R.H. Screws and Nuts .. ..	
4 yards 3 mm. Rubber Flexible Wire .. ..	
1 Anode Clip (Clix) .. ..	
2 yards 18 gauge tinned Copper Wire, Soldering Tags, Washers, etc. .. ..	
Total Price, approx. 18s. 6d.	

## VALVE.

1 Mullard SP4B Metallised, 7-pin, or Mazda AC/52 PEN. Metallised, 7-pin	12/6
---	------

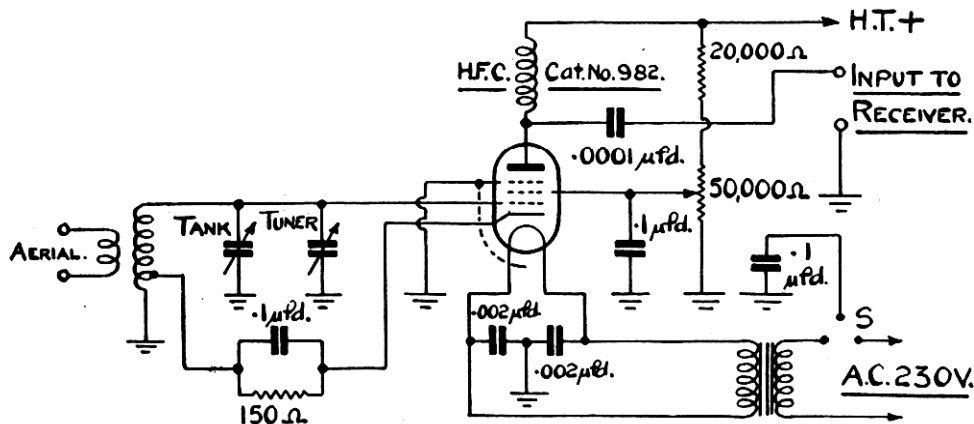

THEORETICAL CIRCUIT DIAGRAM FOR A.C. UNIT.



**Appendix 3: Extract from *Good Health for South Australia*, Issue 137, 1971, pp 1-6 – more biographical info on Dr. George McQueen**



**In This Issue—**

	Page
● RETIREMENT OF DR. McQUEEN . . . . .	1
● "THE DEPARTMENT—PAST AND PRESENT" . . . . .	7
● APPOINTMENT OF ASSISTANT DIRECTOR-GENERAL OF PUBLIC HEALTH . . . . .	21
● LIQUID WASTE DISPOSAL . . . . .	22
● THE BERRI EFFLUENT DRAINAGE SCHEME	23
● RENMARK EFFLUENT DRAINAGE SCHEME	27
● RIVERLAND FRUIT PRODUCTS CO-OP. LTD. WASTE AND EFFLUENT DISPOSAL . . . . .	33

# Good Health

## for South Australia

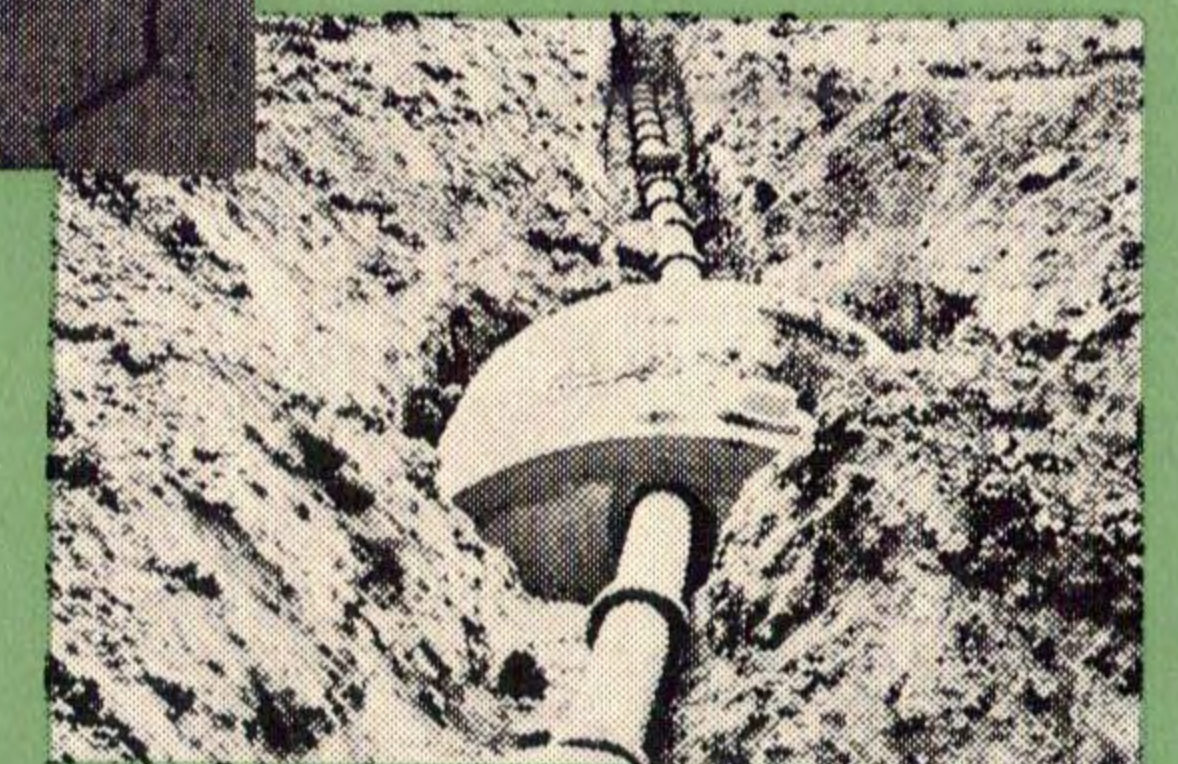
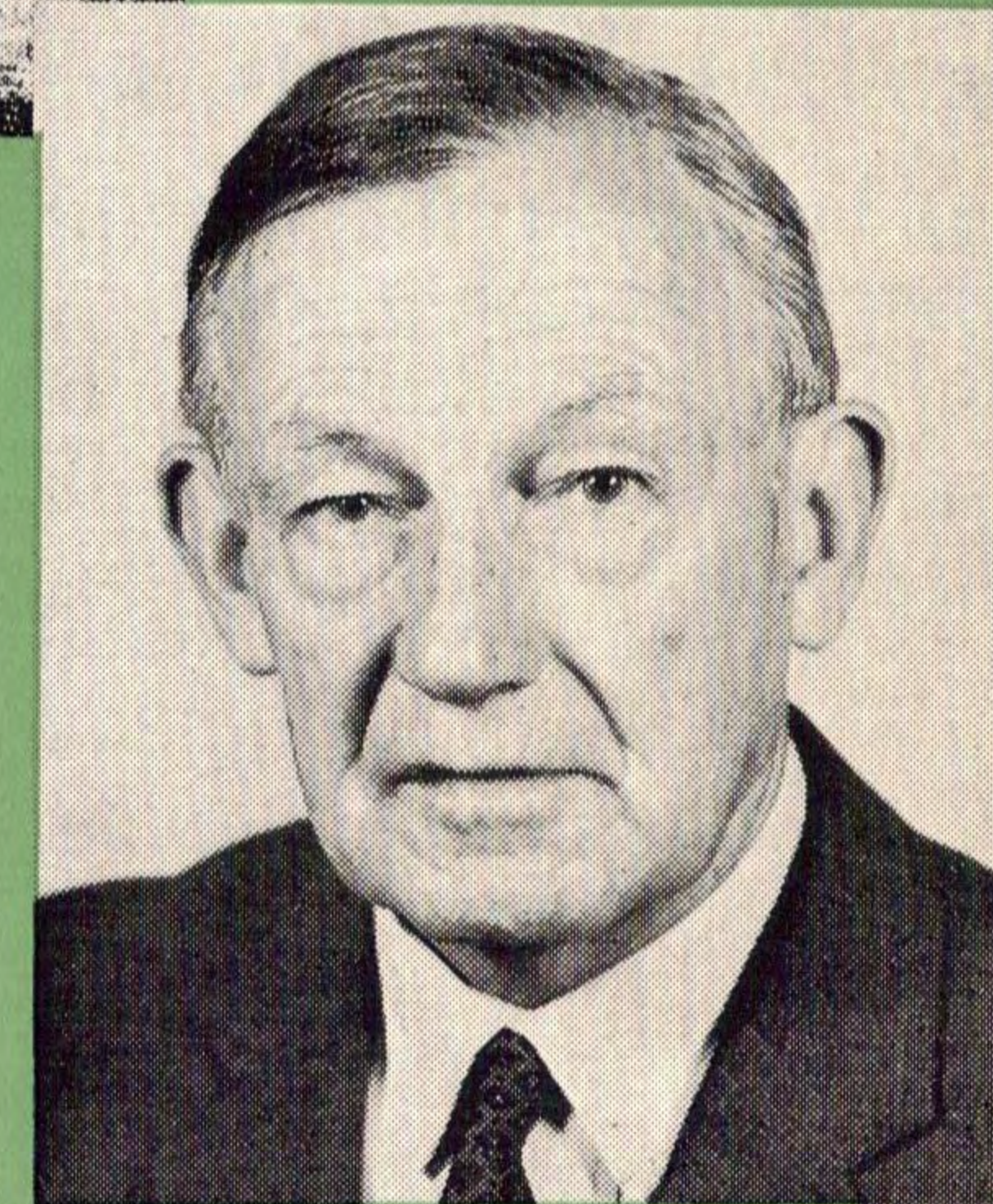
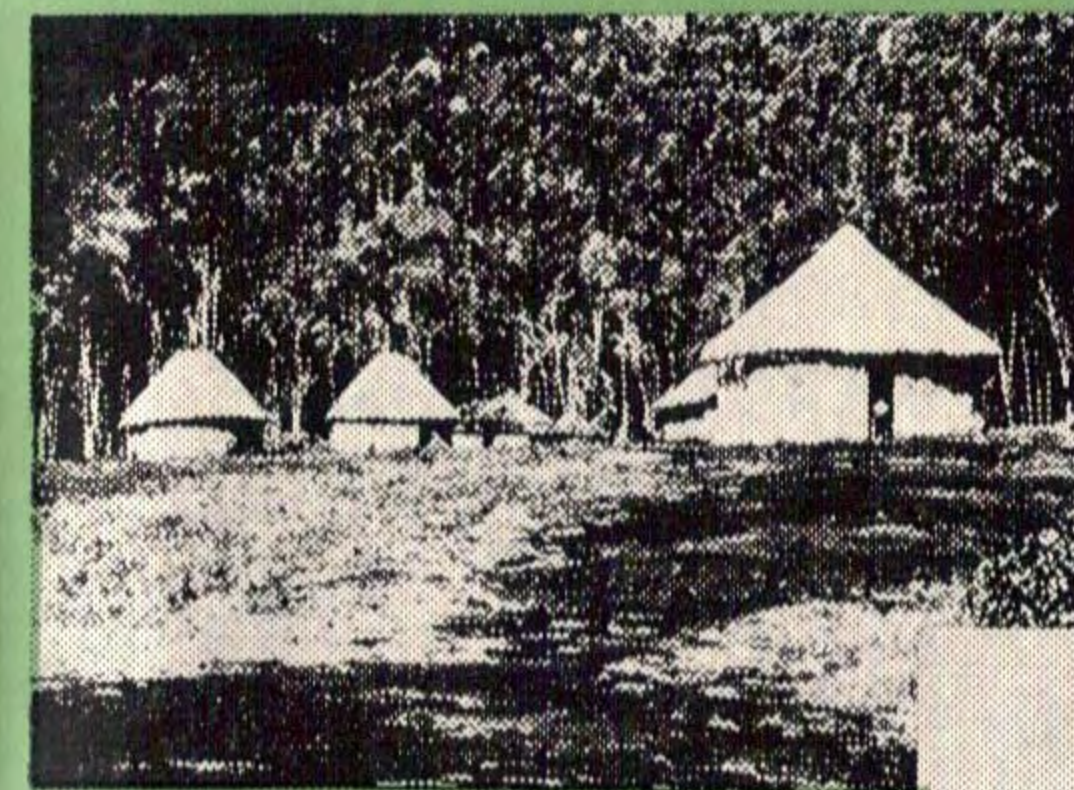



# Good Health

Journal of the Department of Public Health, South Australia

No. 137

ADELAIDE

1971

## RETIREMENT OF Dr. G. H. McQUEEN

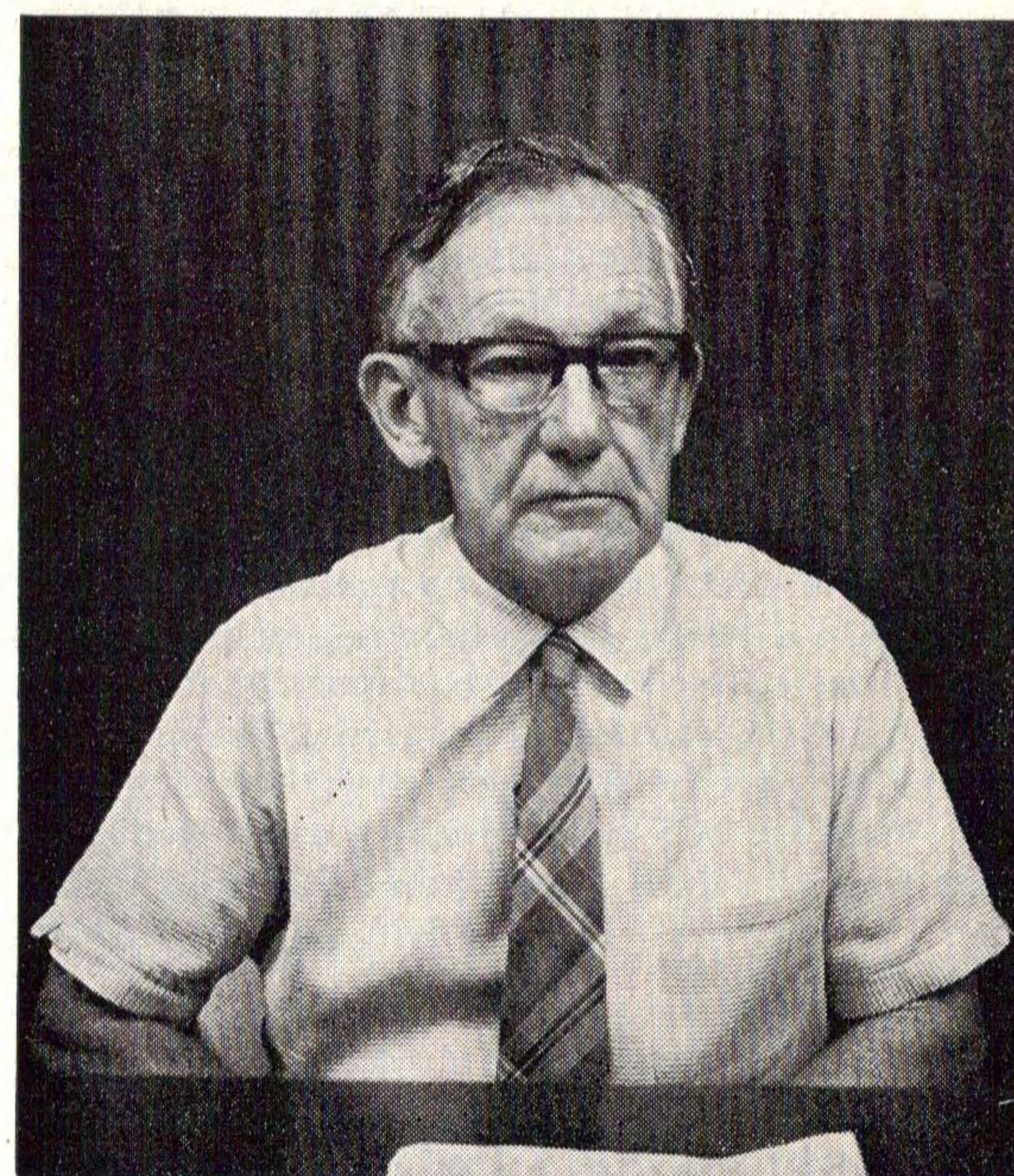

Dr. G. H. McQUEEN

George Hugh McQueen was born at Mount Egerton, Victoria, on 13th April, 1906. His father was then farming in the Goulburn Valley but his mother had returned to the more settled and familiar country near Ballarat and the care of the old family doctor.

His education began at the State School Timmering East No. 2177 and he was later sent to Launceston Grammar as his maternal uncle was a Senior Master at that school. He completed his schooling at Scotch College,



Melbourne, and entered Melbourne University graduating M.B., B.S., in 1928. 1929 and 1930 were spent as Resident Medical Officer and Acting Superintendent at the Launceston General Hospital followed by a year in private practice at Scottsdale in Tasmania.

After joining the Territory of New Guinea's Department of Public Health in 1932, he began a long association with that country that extended from 1932 to 1945. After spending his first twelve months in Rabaul, he was sent as the first medical officer to the Sepik District in the north-west of New Guinea, adjacent to the Dutch border where he remained until 1937. In those days officers served for 21 months followed by 3 months leave and after 6 years were granted additional long service leave which could be taken on half pay. During his first leave period in 1934 he successfully undertook the Diploma of Tropical Medicine at Sydney University. In 1938 he was transferred to the Madang District which was extended to include the Central Highlands area of the Territory from Kainantu to Mount Hagen. He became responsible for establishing medical services throughout the area, spending four weeks in Madang followed by two weeks in the Highlands.

He had undergone compulsory Cadet Training from the age of 14 until he began compulsory C.M.F. training at the age of 18. After graduation from Melbourne University he sat for an Army Examination and was commissioned as a lieutenant. As New Guinea was a League of Nations Territory he was not permitted to hold active service rank there and so was transferred to the Royal Australian Army Medical Corps Reserve, with the rank of captain.

He was on leave in Australia studying for his Diploma in Public Health when war was declared in 1939. The Army was not overly interested in him and eventually General Downes suggested that he should return to New Guinea as a civilian on completion of the course for the Diploma in Public Health and remain in the R.A.A.M.C. Reserve. To those who know him, it is not surprising that George McQueen chose to return to the Madang District (with his Diploma of Public Health) as a Medical Officer in the Territory Service, where he then served from 1939 to 1942.

During this time the people in New Guinea followed the progress of the war in all theatres by short wave radio and he recalls the first sign of the Japanese in Madang was a fortnightly reconnaissance aircraft that became a very familiar sight overhead. During this period the New Guinea Volunteer Rifles was formed, and when the Japanese entered the war the women and children were evacuated and those that remained prepared for the Japanese, who duly arrived in the form of a heavy bomber raid backed up by naval attack bombers. Presumably mistaking the gaol for a military barracks they bombed and destroyed it, killing several native prisoners and wounding others in the process. The only white casualty appeared to be a man who cut his foot while climbing a coconut tree to avoid fire from the attack bombers. Dr. McQueen's recollections of the sight from his slit trench in front of the hospital suggest that the Japanese naval airmen at least, respected the large red cross there, as many planes approached, circled the hospital and flew off without bombing it.

The wounded were moved to a Mission Station up the coast and preparations were made to evacuate Madang. When they finally contacted the authorities at Port Moresby the people in Madang were told that no help was forthcoming and that they would have to fend for themselves. Breaking up into small parties they trekked from Madang over the Finisterre Ranges across the Ramu Valley and up and over the mountains of the Central Highlands of New Guinea to Kainantu in the Wahgi Valley where they set up a widely scattered camp of native huts in an area where the Leahy brothers were running cattle. Dr. McQueen's job at this stage was caring for the health of those in the area and sorting them into those medically fit and those medically unfit for military service. Those who were fit were moved to Wau and Bulolo, while the unfit stayed until the Commonwealth Department of Civil Aviation organized an airlift from the only suitable airstrip in the area at Mount Hagen.

He had, however, another important job. When no butchers remained in the party he was elected, in view of his knowledge of anatomy, to slaughter the cattle to augment the food crops which had already been planted by district officers in anticipation of the evacuation from Madang. As an old Rifle Blue from Melbourne University he had no difficulty in shooting his selected beast. He had agreed to carry out the butchering on the condition that he got first choice of the cuts. He recalls that he found the tender flesh of the perineal area could be cooked immediately and this was a portion he always claimed for the occupants of his grass hut. He still claims it was better than the best undercut steak and considers they lived extremely well as far as food was concerned during this period at Kainantu.

He recalls that one of the party who had learned to fly, returned to Madang with a small party, rendered the airfield there temporarily serviceable and flew a light aircraft from Madang back over the mountains to Mount Hagen. The same pilot subsequently flew across to the southern Dutch New Guinea coast, crash landing on a beach and completing his journey to Thursday Island by canoe. In Sydney he organized the airlift to evacuate the unfit, returning on the first aircraft to Mount Hagen. Anyone with a knowledge of aviation at that time and New Guinea in particular will understand what a truly remarkable feat this flight was.

The New Guinea people who were fit and still remained in the valley joined the New Guinea Volunteer Rifles while the unfit and service personnel collected from many areas, particularly escapees from Rabaul, Manus and other islands to the north, were evacuated to Horn Island and then to Australia. Although his exact status was uncertain, Dr. McQueen and a Sister from Madang Hospital were amongst the last to be evacuated by air to Horn Island and eventually to Melbourne. Even though she had walked half-way across New Guinea the Sister was subsequently rejected for military service because of flat feet.

The Territory Civil Service had been taken over by the Commonwealth Department of External Territories and Dr. McQueen found himself under their control. Attempts to enlist in the A.I.F. were at first unsuccessful. He then tried the Royal Australian Air Force but this was too much for



the Army who recalled him and he reported to Army Headquarters to Major-General Burston who promptly posted him to an anti-aircraft unit in Melbourne. Apparently finally realizing his experience and qualifications he was later posted as Deputy Assistant Director of Hygiene (D.A.D.H.) to a unit in Western Australia after first completing a two weeks' course at the Army Hygiene School in Sydney!

He left Sydney by train to take up his new posting but was taken off the train in Melbourne and told that he was going to New Guinea that night as D.A.D.H. of the 11th Australian Infantry Division. He was issued with all his tropical gear except a mosquito net and despite vociferous protest was sent off by plane to Brisbane with a promise that he would get a mosquito net there. In Brisbane with no mosquito net apparently available, George McQueen in what many of us know as a typical stand, refused to leave Australia without a mosquito net.

He was eventually taken by Army staff car to the centre of Brisbane and permitted to go shopping until he had acquired a suitable mosquito net. As an old New Guinea hand, his kit was reduced to the bare essentials and he recalls standing on the upper decks of the *Anchun* watching the troops come on board with heavy overcoats, duffle bags and full cold climate kit. When he queried the apparent lack of mosquito nets, he was told that they were packed in the hold and they would be issued in New Guinea. Before the *Anchun* reached Milne Bay the area was controlled by the Australians during the day and the Japanese navy at night. The authorities said it was now reasonably safe to leave ships in the harbour overnight but they watched with some doubt that night as Japanese naval vessels came in after dark, ordered an Australian hospital ship to get out of the way, shelled shore positions and sank the *Anchun* with all the mosquito nets still in the hold. Dr. McQueen suggests that some 95 per cent of those troops that arrived on the *Anchun* got infected with malaria during the first night at Milne Bay.

The following night, the battle at the first airstrip, some five miles from his headquarters was fought and the Japanese were defeated for the first time in their previously triumphant march south. As D.A.D.H. of the 11th Australian Infantry Division, Dr. McQueen took control of the health of troops in the Milne Bay area. From then on he found himself being transferred to new units as they arrived in New Guinea and any requests for leave were generally met with the statement, "But this is where you live, why do you want to go to Australia?"

Later, Don Wilson, our Chief Inspector in the Department, met Dr. McQueen at Buna during the Buna-Dobadura-Salamaua campaign, and this was the beginning of their long association. Don recalls that casualties from infectious diseases outweighed battle casualties by some 20 : 1, and Dr. McQueen's long experience in New Guinea was finally fully realized when he joined New Guinea Force Headquarters where he played a major part in the control of diseases among Australian Forces in New Guinea and in writing a manual for prevention of diseases in tropical areas which was adopted by the Australians throughout the South-West Pacific area. Liaison with the Americans was established and they adopted some of the manual particularly the section relating to refuse disposal.

Dr. McQueen was given the honour of being mentioned in despatches for the work he did with the A.I.F. in New Guinea. During one of his few leaves he managed to reach Melbourne, and he was married there on 6th March, 1945, to Edith, the daughter of Mr. and Mrs. George McKay, of Sunshine, Victoria. He finally left the island of Bougainville in the Territory of New Guinea just before the Japanese surrender in 1945, when he was posted to Second Army Headquarters based at the Oatlands Golf Club, at Parramatta, in Sydney.

Inactivity and Major McQueen never made good bedfellows and he secured a posting as O.C. Camp Hospital, Liverpool, where he spent his remaining time in the Army ensuring that the creature comforts like food and towels were again made available to an Army hospital in Australia that somehow had always missed out. He was still in the Army when he applied for a job in South Australia and by letter he was appointed as a medical officer in the South Australian Department of Public Health. He commenced duty on 1st July, 1946. In 1950 he was appointed to the post of Senior Medical Officer and in 1957 he was appointed to the position of Principal Medical Officer, Public Health.

The writer was privileged to work with him from 1956 until the present time and I am sure those who worked with him throughout this period would agree with me when I say he richly deserved his appointment as Assistant Director-General of Public Health in 1967.

George McQueen brought to Public Health work in South Australia, a wealth of experience and sound practice in the art of Public Health. He will forgive me I know if I say that only after close association did one begin to realize the ability of the man in this field and many of the developments of which South Australians may be truly proud were originated by George McQueen during this time. In my early days in the department another old New Guinea hand, the late Charles Mervyn Deland, was a medical officer in the department and I can remember many pleasant lunch hour sessions when the two old New Guinea hands began swapping stories about their time in the Territory, one suspects at times without a great deal of prompting.

At the first Departmental In-Service Conference at Raywood in the Adelaide Hills, George McQueen read a paper which I feel sums up admirably the era of Public Health in this State to which he contributed so much, and as a tribute to him this paper is reproduced in this issue of *Good Health*.

If one looks at Dr. McQueen's additional appointments and qualifications the wealth of experience suggested by this brief pen picture is again confirmed. In addition to having the Diploma of Public Health and Diploma in Tropical Medicine, he is a Fellow of the Royal Society of Health and Chairman of that Society's Examining Board in South Australia, a Fellow of the Royal Society of Tropical Medicine and Hygiene and a Fellow of the Australian College of Medical Administrators. He has been Honorary



Epidemiologist at the Royal Adelaide Hospital since 1953 and a demonstrator in Public Health and Preventive Medicine at the University of Adelaide since 1948. He is a member of the Post Graduate Committee in Medicine at the University of Adelaide, the Occupational Health Committee of the National Health and Medical Research Council, the Radiological Advisory Committee of South Australia (since 1960), and the Clean Air Committee of South Australia (since 1964). He has been elected Vice President of the South Australian Branch of the Australian Public Health Association and his term of President in 1972 will be fitting tribute for when Dr. McQueen retires on the 12th April, 1971, an era of Public Health in South Australia will come to an end.

I would like to quote a paragraph from our Departmental Newsletter "P.H.D."—

"Public health in this State will suffer a great loss when Dr. McQueen retires. He has seen the department grow and has had a hand in almost every part of its development. Those of us who have had the privilege to work with him have appreciated his guidance, quiet efficiency, kindness and loyalty. Dr. McQueen may leave the department but much of his philosophy will remain for many years to come. We all wish Dr. McQueen the very best and hope he spends many years of happiness doing those things he likes doing best in his new life ahead."

With this I concur

C. O. FULLER, PMO Environmental Health

## "THE DEPARTMENT—PAST AND PRESENT"

ADDRESS BY DR. G. H. MCQUEEN, ASSISTANT DIRECTOR-  
GENERAL OF PUBLIC HEALTH\*

Having heard about what we would like to do in the future and more importantly what we can afford to do and still more important what we will be allowed to do, you are now to hear a very brief outline about what we have done in the past, and what we are doing now.

Looking back it becomes apparent that South Australia has often taken an individualistic role in the history of Australia. Perhaps because of its early isolation from the Eastern States and the origin of its early immigrants, many developments here have not followed the pattern followed in the older States.

Occupation of South Australia by people of European origin commenced in the early years of the 19th century. However, South Australian history began officially some time later with the arrival in 1836 of H.M.S. *Buffalo*—a ship which if hearsay is correct must have been grossly overcrowded and over-loaded.

History records that "freedom from any serious amount of sickness" during the early years of the State could be attributed to "our very fine climate and to the city not being very densely populated".

In 1848 the first Public Health Act became law in the United Kingdom where, in that same year more than 54,000 people died from cholera alone during one of the many epidemics that swept across Europe about that time.

Epidemics in other parts of the world and an increasing number of undesirable conditions in Adelaide lead to the passing of the first Health Act in South Australia in 1873. It was described in Parliament as "an Act to make provision for the preservation and improvement of the Public Health". Reference was made in Parliament to "filthy emanations from boiling down establishments and such concerns at Hilton. The number of slaughterhouses allowed to exist close to the city on the banks of the Torrens. Annoyance caused by the presence of noxious smells—a city of stench".

The Act provides for a central authority—the Central Board of Health—with power to execute the requirements of the Act. These included disposal of rubbish, abatement of nuisances, seizure of unwholesome food, powers of inspection, and authority to make regulations "to check the spread of epidemic, endemic, or contagious diseases".

Town Councils were constituted Local Boards of Health with powers similar to the Central Board in their own areas. District Councils could also be constituted Local Boards of Health. Local Boards were required to maintain good sanitation in their areas. They could be directed to carry out specified works by the Central Board and if they defaulted, the Central

\*Read at the Departmental In-Service Conference at Raywood, October, 1969.



**Appendix 4: A W2 Reviews – *Wireless World*, 1936, *Practical & Amateur Wireless*, 1936**



# New Apparatus

## Reviewed

### GLIMM VOLTMETER

THIS is quite a novel type of voltmeter, as it does not include any moving parts, voltage being indicated by a glow in a small neon tube. It can be used on either AC or DC supplies, and will answer as an indicator for direct or alternating current by the position of the glow about the electrodes. On DC the glow is confined to one electrode only, whereas on AC it is equally distributed about both.

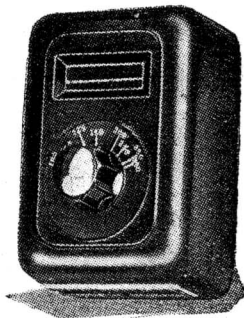

Neon-type voltmeter for AC and DC measurements.

The meter is provided with a knob and scale calibrated from 100 to 440 volts. Having joined the instrument across the points where a measurement is required, the knob is adjusted so that a faint glow just appears between the two electrodes. The voltage is then read off the scale. It is surprisingly accurate for a neon device, and its measurements agree very well with those made with other instruments.

Its most useful feature is that current consumption is practically nil; for example, at 200 volts it passes less than 0.05 mA.

It is obtainable from Eugen J. Forbat, 28-29, Southampton Street, Strand, London, W.C.2, and the price is 27s. 6d.

### L.T.P. OUTPUT TRANSFORMER

THE transformer illustrated is one of the new range now being made by London Transformer Products, Ltd., L.T.P. Works, Cobbold Road, Willesden, London, N.W.10.

This particular model provides two ratios, viz.,  $2\frac{1}{2}$  to 1 and 15 to 1, and is designed

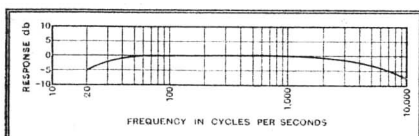

Response curve of the L.T.P. two-ratio output transformer.

to carry DC currents up to 90 mA., and is suitable for use with power valves giving up to about 10 watts AC output.

The windings are sectionalised to keep the

### Recent Products of the Manufacturers

leakage inductance small, and to render it suitable for tropical use it is thoroughly impregnated.

Our measurements give the primary inductance as 35 henrys without DC flowing, 29 henrys with 40 mA., 24 with 60 mA., and 20 henrys with 90 mA. The resistance of the primary is 270 ohms.

The response characteristic was taken following a valve requiring a load of 4,000 ohms and the 15 to 1 ratio was employed with a suitable resistance joined across the secondary. The curve obtained with this combination is given in the accompanying graph. It is quite satisfactory, as the response is virtually constant over the major part of the audible scale.

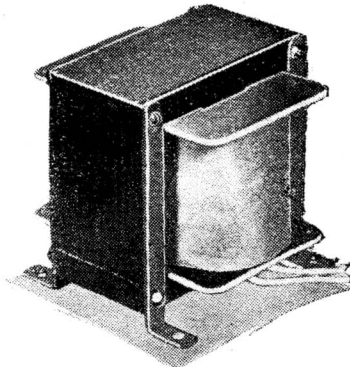

Manufacturers' type two-ratio output transformer made by London Transformer Products.

As a skeleton, or manufacturers' type, the price is 24s. 6d., but the transformer can be obtained in a more attractively finished form with shrouded windings and terminals for an additional 4s.

### EDDYSTONE ALL-WORLD-TWO RECEIVER

THIS new Eddystone receiver is a compact two-valve model designed expressly for short-wave reception. It is supplied as a kit of parts, but the assembly is perfectly straightforward, the layout being very well planned so that all components are readily accessible.

An HF pentode is used for the detector, and this is resistance-capacity coupled to a small power output valve, for, as a rule, headphones only will be used with this set. Either a triode or a pentode can be used in the output position, and a choice of valves is given in the instructional booklet. These have been chosen with a view to economy in operation, and by adopting the maker's recommendations the total HT

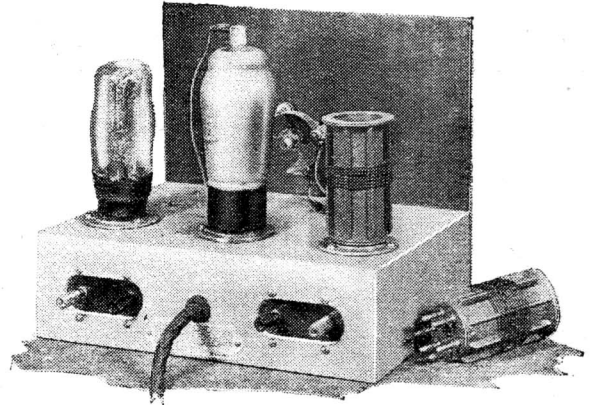

Eddystone All-World-Two receiver assembled from the kit of parts.

consumption can be kept within 5 mA. with a 120-volt battery.

Reaction is obtained by capacity-feed-back through a reaction coil, but control of detector oscillation is effected by varying the screen voltage.

This arrangement is very satisfactory in practice, for the smoothness of the regeneration is one of the outstanding features of this receiver.

The Eddystone band-spread tuning system is employed, the small band-spread condenser, which has about 20 m-mfd capacity, being mounted in the centre and fitted with a neatly engraved scale, while the "tank" unit is located on the left and below the chassis.

The drive reduction ratio of the band-spread unit is about  $8\frac{1}{2}$  to 1, but this is quite slow enough in view of its small capacity.

Standard six-pin plug-in coils are used, and with the Eddystone Type 6LB size the waverange covered was found to be 15.75 to 29.6 metres. At the bottom end of this band the band-spread condenser gave a coverage of two metres, whilst at the top it was reduced to just over one metre.

The band-spread system is a great help, for, despite the small capacity of this condenser, some care is needed in tuning, especially at the lower end of the Type 6LB coil.

The next size coil, Type 6Y, overlapped the other one amply sufficient to take care of variation in stray capacities in different sets, its range being 27.3 metres to 54 metres.

The sensitivity of this set is exceptionally good, so also is the selectivity, for it is possible to receive DJN Zeesen, 31.45 metres, clear of its companion transmitter DJA on 31.38 metres, with one an R8 signal, and yet leave a clear space between them. For a simple detector-LF set this is very satisfactory.

European and American short-wave stations were received well during the time the set was on test, though conditions must be favourable for good reception of the latter.

To sum up, the All-World-Two is a soundly designed and very efficient detector-LF set, and as it is so easy to operate it is ideal for the beginner, yet it forms a valuable stand-by for the more experienced short-wave experimenter.

The price of the complete kit is £3 7s. 6d., and the valves cost 20s. 6d. extra. The makers are Stratton & Co., Ltd., Bromsgrove Street, Birmingham, 5.



# THE EDDYSTONE ALL-WORLD TWO KIT

THE new short-wave, two-valve receiver which has just been issued by Messrs. Stratton and Co. for home assembly is shown in the two illustrations on this page in completed form. This is a novel kit in several directions, the most important of which is the form of chassis which is employed. This is a die casting 8½ins. by 6ins. and 2½ins. deep, and this includes on the under side a short pillar which is used as an anchoring point for one of the condensers employed in the circuit. Holes for the valveholders and slots for the terminal connecting strips are provided in the casting, and these components are attached to the chassis by means of nuts and bolts. The complete kit includes the necessary connecting wire and screws in addition to the

(it can only be adjusted from beneath the chassis). The usual grid-leak and condenser connections are adopted, but the screening grid of the detector valve is connected to the arm of a potentiometer joined across the H.T. circuit so that the best value may be found on test. The reaction circuit is completed through a pre-set condenser, the adjusting screw of which is immediately beneath a hole in the upper surface of the chassis, and thus it may be adjusted to such a value that the control of the screening-grid potential will provide the reaction control and this gives a very smooth arrangement which is even better than the normal capacity controlled reaction circuit of a triode valve. Added to this, there is an increased amplification which is very useful in a small receiver of this type.

\*\*\*\*\* DON'T  
JUST READ THIS  
ITEM !!!

\*\*\*\*\* BUILD IT  
yourself !!!

\*\*\*\*\* EUG will  
supply you with a  
circuit diagram.

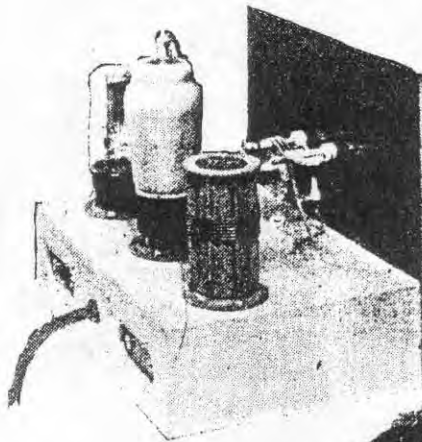

*In the above illustration the receiver is seen ready for use, and on the right the completely wired kit is seen from the underside to show the neat arrangement of the component parts.*

components, which are very few indeed for this particular receiver. The circuit employed is a simple detector and L.F. arrangement, the detector valve being of the H.F. pentode type, and the coupling between detector and L.F. valve being of the resistance-capacity type. A six-pin coil is employed for the aerial circuit, and this is tuned by a microdenser fitted with a slow-motion gear. To operate this condenser one of the well-known Eddystone two-inch knobs is employed with a travelling cursor which passes over an engraved aluminium dial, and a band-spread condenser is mounted beneath the chassis and provided with a ten-section divider plate. It will thus be seen that this combination takes the form of the band-spread tuning unit which was reviewed in our issue dated April 18th last, and which provides, in effect, a reduction gear of 90 to 1.

## Circuit Details

The aerial is connected to the primary winding of the coil through a small "pre-set" condenser which may be adjusted when setting up the circuit to the best value

## Test Results

The receiver was tested on our normal aerial and gave very good results. The principal feature which was noticed was the effectiveness of the reaction control, which functioned noiselessly and smoothly, giving a gradual build-up from the weakest signal to smooth oscillation when the pre-set condenser was correctly adjusted. The receiver was very free from hand-capacity effects. The effectiveness of the band-spread tuning combination enabled stations to be located as easily as on a standard broadcast receiver, and the All-World Two will provide the listener with hours of

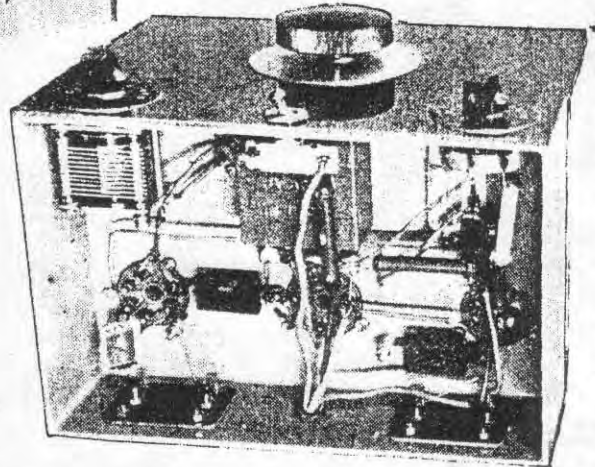

interesting entertainment at all hours of the day. The price of the kit is £3 7s. 6d., and two valves for the receiver will cost 20s. 6d.

## SPECIFICATION

**KIT:** All-World Two Assembly.

**DETAILS:** Detector and L.F. circuit with single 6-pin plug-in coil which may, of course, be changed for any desired wavelength. All metal die-cast chassis, with paxolin panel and modern low-loss components. Band-spread tuning adopted in the aerial circuit.

**CIRCUIT:** Pen. grid-leak detector with resistance-capacity coupled L.F. stage. Reaction controlled by varying the screening grid voltage, with pre-set reaction condenser in usual circuit. Interchangeable plug-in coils.

**PRICE:** £3 7s. 6d. (plus 20s. 6d. for valves).  
**MAKERS:** Stratton and Co., Ltd., Eddystone Works, Bromsgrove St., Birmingham, 5.



# THE EDDYSTONE ALL-WORLD TWO KIT

*In the issue for June 12<sup>th</sup> 1936, Practical and Amateur Wireless (now P.W.) reviewed Stratton's new (and to be the longest-running) kit-set. The All-World Two remained in production as a kit and was also factory-built until the fall of France in 1940. It was used by Voluntary Interceptors (civilian monitors for military intelligence) in the early years of Bletchley Park and the Ultra de-coding service.*

The new short-wave, two-valve receiver which has just been issued by Messrs. Stratton & Co. for home assembly is shown in the two illustrations on these pages in completed form. This is a novel kit in several directions, the most important of which is the form of chassis which is employed.

This is a die-casting 8½ins. by 6ins. and 2½ins. deep, and this includes on the under side a short pillar which is used as an anchoring point for one of the condensers employed in the circuit. Holes for the valve-holders and slots for the terminal connecting strips are provided in the casting, and these components are attached to the chassis by means of nuts and bolts.

The complete kit contains the necessary connecting wire and screws in addition to the components, which are very few

indeed for this particular receiver. The circuit employed is a simple detector and L.F. arrangement, the detector valve being of the H.F. pentode type, and the coupling between detector and L.F. valve being of the resistance-capacity type. A six-pin coil is employed for the aerial circuit, and this is tuned by a microdenser fitted with a slow-motion gear.



To operate this condenser one of the well-known Eddystone two-inch knobs is employed with a travelling cursor which passes over an engraved aluminium dial, and a band-spread condenser is mounted beneath the

chassis and provided with a ten-section divider plate.

It will thus be seen that this combination takes the form of the band-spread tuning unit which was reviewed in our issue dated April 18<sup>th</sup> last, and which provides, in effect, a reduction gear of 90 to 1.



### Circuit Details

The aerial is connected to the primary winding of the coil through a small "pre-set" condenser which may be adjusted when setting up the circuit to the best value (it can only be adjusted from beneath the chassis). The usual grid-leak and condenser connections are adopted, but the screening grid of the detector valve is connected to the arm of a potentiometer joined across the H.T. circuit so that the best value may be found on test.

The reaction circuit is completed through a pre-set condenser, the adjusting screw of which is immediately beneath a hole in the upper surface of the chassis, and thus may be adjusted to such a value that the control of the screening-grid potential will provide the reaction control.

This gives a very smooth arrangement that is even better than the normal capacity controlled reaction circuit of a triode valve. Added to this, there is an increased amplification which is very useful in a small receiver of this type.

### Test Results

The receiver was tested on our normal aerial and gave very good results. The principal feature which was noticed was the effectiveness of the reaction control, which functioned noiselessly and smoothly, giving a gradual build-up from the weakest signal to smooth oscillation

when the pre-set condenser was correctly adjusted. The receiver was very free from hand-capacity effects. The effectiveness of the band-spread tuning combination

enabled stations to be located as easily as on a standard broadcast receiver, and the All World Two will provide the listener with hours of interesting entertainment at all hours of the day. The price of the kit is £3 7s. 6d., and two valves for the

receiver will cost 20s. 6d.



### SPECIFICATION

**KIT:** All-World Two Assembly.

**DETAILS:** Detector and L.F. circuit with single 6-pin plug-in coil which may, of course, be changed for any desired wavelength. All metal die-cast chassis, with paxolin panel and modern low-loss components. Band-spread tuning adopted in the aerial circuit. (*Later models had metal panels and cases, see advert - Ed*)

**CIRCUIT:** Pen. grid-leak detector with resistance capacity coupled L.F. stage. Reaction controlled by varying the screening grid voltage, with pre-set reaction condenser in usual circuit. Interchangeable plug-in coils.

**PRICE:** £3.7s. 6d. (plus 20s. 6d. for valves)

**MAKERS:** Stratton and Co., Ltd., Eddystone Works, Bromsgrove Street, Birmingham, 5.



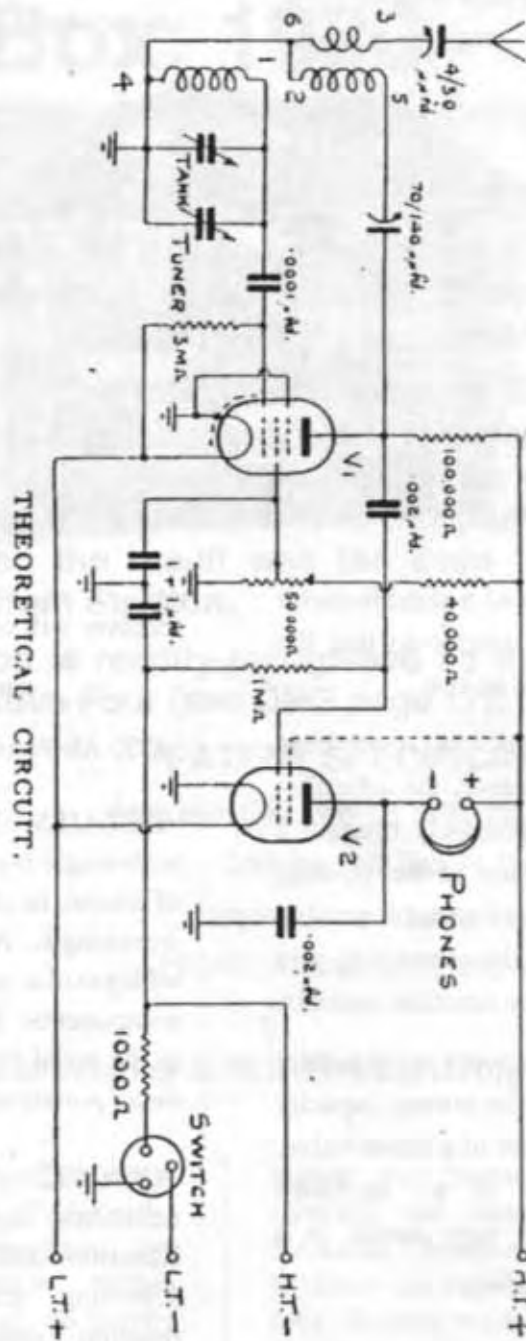

Circuit Diagram of the Eddystone All World Two



**Appendix 5: Reviews and selection of adverts for the AW2 and related components in *Wireless World***



# IT PAYS TO BUY THE BEST

UNIVERSAL S.W. VALVE-HOLDER



A low loss holder for above or below baseboard use. The valve enters the contacts from either side. There is no measurable increase of self capacity to that already in the valve base. DL-9 H.F. dielectric, one piece noiseless contacts. No. 1015 4-pin 1/3d. No. 1016 5-pin 1/5d. No. 1024 7-pin 1/8d.



### INTERCHANGEABLE COILS.

New low loss formers of DL-9 high frequency insulation. Rapidly made and each coil matched. First class results assured. 4-pin coils have two windings, 6-pin three windings. No. 959 6-pin Set of 4 12-170 metres Price 16/- No. 932 4-pin " " " " Price 14/-

STRATTON & CO. LTD., Bromsgrove Street, BIRMINGHAM. London Service Depot: Webb's Radio Stores, 14, Soho Street, Oxford Street, W.1.

# EDDYSTONE

SHORT WAVE COMPONENTS

## NOW you can afford to CHANGE TO VELOCITY MICROPHONES!



**HIGH FIDELITY... BRILLIANCY... DEFINITION**

Whenever sound reproduction of the highest fidelity is wanted, the Velocity type microphone should be used. Now Amperite brings the finest in Velocity Microphones within your reach. Actual performance tests prove the superiority of our Studio Model SR-80 to other microphones, regardless of price. Covers entire frequency range without introducing resonant peaks of its own. Frequency response 30 to 14,000 CPS. Output—64 db open line. Perfect definition of instruments in ensemble work. Available in High Impedance Model, which eliminates input transformer. PRICES and COMPLETE DETAILS in BULLETIN SM-1.

### FOR ANNOUNCING, REMOTE, PUBLIC ADDRESS

The Amperite Velocity Model RB features new super fast Nickel Aluminium magnets, magnets more powerful than even 35% Cobalt! No resonant peaks. Therefore gives perfectly lifelike (not mechanical) reproduction. Does not tire the listener. Eliminates acoustic feedback. Available in High Impedance Model RB-H, which eliminates separate pre-amp. COMPLETE STORY in BULLETIN PA-2.



### FOR "SPOT" BROADCASTING, 7-POINT JR.

The Little Velocity, Uniform output with speaker's head at any angle. Output practically equal to large velocity. Frequency response 60-7500 cycles. Size of match box. Weight, 8 oz. Write for BULLETIN 7L.

### A-C PRE-AMP and LINE AMP.

Transformer coupled and guaranteed humless. Frequency range 30 to 15,000 cycles (1 db.) Hum level, -100 db. Write for prices and complete description.



... ALSO NEW COMPLETE LINE OF MICROPHONE STANDS

AMPERITE Co. 561 BROADWAY, NEW YORK, U.S.A.

Cable Address: Alben, N.Y.

# AMPERITE Velocity MICROPHONE

## COMPONENTS—SECOND-HAND, CLEARANCE, SURPLUS, ETC.

M.R. SUPPLIES

M.R. SUPPLIES

M.R. SUPPLIES Draw Your Earnest Attention to Their Displayed Advertisement on Page 1, and invite you to send 1/6d. stamp for their latest illustrated list—11, New Oxford St., London, W.C.1.

**R**YALLS RADIO, 280, High Holborn, London, W.C.1, all goods previously advertised still available. [1125]

**A**BOLISH Aerials, something new, clearer better reception, attached to set in a moment, no aerial needed; price 2/6, post free.

**W**ELL KNOWN 21/- Pickups, 9/6; electric photocell, 10/-; H.T.8, 7/6; electric soldering irons, A.C./D.C., 1/9; A.F.5, 10/-; S.W. coils, set 3, 4/6, 12-60 metres; P.M. Blue Spot speaker, 12/6; R.A. P.M. speaker, 10/-; Philips A.C. eliminator, H.T. and G.B., 17/6; ditto D.C., 10/6; Alma D.C. Radiogram, £6/10; 1936 Burgoyne Universal 4, A.C./D.C., 84/-; M.P.R. A.C. charging plant, 120 cells, Westinghouse rectifier, 75/-; Ferranti D.C. speaker, 15/-; orders under 5/- add 3d. extra postage; all goods despatched same day; let us quote you prices.—The Exchange Mart, 67, Porter St., Hull. [1179]

**W**ARD for Unparalleled Bargains in Set Manufacturers' Surplus; all goods are guaranteed unused and perfect; immediate delivery.

**G**ARRARD Universal Gramophone Motors, with auto-stop, etc., £2/10; Blue Spot Class "B" output chokes, 3/6.

**B**RITISH Radiophones Condensers, fully screened, super-bet or straight types, 3-gang and 2-gang; 7/6.

**C**ENTRALAB Resistances, 1-watt type, 6d.; 2-watt type, 1/2; 3-watt type, 1/9; B.I.C. 8 mf. and 4 mf. 550 volts peak electrolytic condenser, 3/3.

**C**LLIX Chassis Type Valve Holders, 4- or 5-pin, 6d.; 7- or 9-pin, 6d.; R.C.A. American valve holders, 4-, 5-, 6-, or 7-pin, 9d.

**M**ARCONI Model 25 Pickups, 21/-; Cosmocord, 12/-; B.T.H. pick-up tone arms, 3/-.

**C**ONVERSION Units for Converting D.C. Receivers to A.C. mains operation, up to 80 watts; £2 each.

**A**.C. and D.C. Eliminators, first class make, tapping, S.G. detector, and power, 150v. 25 m.a., D.C. type, 12/-; A.C. type, with Westinghouse rectification, 25/-; A.C. type with 0.5 amp. trickle charger, 30/-.

**S**KELETON Type Westinghouse Rectifiers, H.T.8, 9/6; H.T.9, 10/-; H.T.10, 10/9; L.T.4 or L.T.5, with mains transformer, 18/6.

**M**AINS Transformers.—350-0-350v. 60 m.a., 4v. 4 amps., 4v. 25 amps., 12/-; 425-0-425v. 120 m.a., 4v. 1 amp., 4v. 1 amp., 4v. 7 amps., 4v. 2.5 amps., for "W.W." Quality Amplifier, 26/-; L.T. transformers, with two 4-volt 3a. C.T. windings, or 2.5v. 8a. 5v. 2.5a., 8/6.

**V**OLUME Controls, with or without switch, by Rotor-ohm, Centralab and other good makers, any value, 2/6.

**W**E Stock All Parts for "Wireless World" Quality Amplifier and Quality Amplifier Receiver.

**"EUROPA"** Continental Valves, all types in stock; A.C. or A.C./D.C. (20 volts, 0.18 amps.), variable-mu, output triodes, detectors, etc., 4/6 each; output pentodes, 5/6; 500-volt rectifiers, indirectly heated or otherwise, 7/-; we can also supply a correct replacement for any British type of valve, including side-contact universals, and 60-watt output triodes; price upon request.

**C**ARRIAGE Paid; cash with order or c.o.d.; send for list.

**W**ARD, 46, Farrington St., London, E.C.4. Tel.: Holborn 9703.

**R**ICH-BUNNY Super Output Choke, 150 m.a., 17/6; B.T.H. Senior pick-up, 15/-; A.F.5, 10/-; electrostatic, D type, 10/-—Getliffe, Retford. [1156]

## TRANSMITTING APPARATUS

**C**RYSTALS, 80 metres, also few 160, for sale; 5/- each.—Radio, G6MY, Morley, Yorks. [1152]

**R**ADIOMART Carries Largest Stocks British and American Gear, E.O.I. Ceramic coil forms, bottles, Hammarlund gear, etc.; personal attention.—G5NI, G2AK, 44, Holloway Head, Birmingham. [10507]

## CINEMA EQUIPMENT

**M**OVIE Projectors and Cameras, films, 8, 16 and 35 mm., silver screens, beaded screens, Ilustra Enterprises, 159, Wardour St., London. [10486]

## MISCELLANEOUS

**C**HEAP Printing.—1,000 billheads, 3/6; samples free.—Cretaway Press, 18, Buxted, Sussex. [1038]

**E**LECTRIC Motors, drills, grinders, A.C./D.C., all voltages; from 18/-; lists free; repair specialists.—Enaco, Electrical Service, 18, Brixton Rd., S.W.9. [10456]

**A**IR FORCE.—Young men will be wanted as engineers, clerks, etc.; our postal courses will get you through the entrance examinations; particulars free.—Dept. 92, The Bennett College, Ltd., Sheffield. [10505]

**W**IRELESS Industry Offers Well-paid Posts to Qualified Men. By studying at home with the T.I.G.B. you, too, can become qualified; write to-day for "The Engineer's Guide To Success"—free, which contains world's widest choice of wireless and engineering courses; over 200, and gives full particulars of the examination regulations for A.M.I.E.E., A.M.I.W.T., B.Rad.A., C. and G., etc.; mention branch, post or qualification that interests you.—The Technological Institute of Great Britain, 85, Temple Bar House, London, E.C.4. (Founded 1917. 19,000 Successes.) [1050]

# Let Us Send You This 40-Page Booklet—Free



It gives full information regarding various I.C.S. Courses of Instruction in Radio work.

The Radio Industry is progressing with amazing rapidity. Only by knowing thoroughly the basic principles can pace be kept with it. I.C.S. Instruction includes American broadcasting as well as British wireless practice. It is a modern education, covering every department of the industry.

## OUR COURSES

Included in the I.C.S. range are Courses dealing with the Installing of radio sets and, in particular, with their Servicing which to-day intimately concerns every wireless dealer and his employees. The Equipment Course gives sound instruction in radio principles and practice.

There is also a Course for the Wireless Salesman. This, in addition to inculcating the art of salesmanship, provides that knowledge which enables the salesman to hold his own with the most technical of his customers.

Then there are Preparatory Courses for the City and Guilds and I.W.T. Exams.

We will be pleased to send you details and free advice on any or all of these subjects. Just fill in and post the coupon, or write in any other way.

International Correspondence Schools, Ltd.  
Dept. 38, International Buildings,  
Kingsway, London, W.C.2

Without cost or obligation, please send me your "Radio" booklet of information about the Courses I have marked X.

- COMPLETE RADIO
- RADIO SERVICING
- RADIO EQUIPMENT
- RADIO SERVICING & SALESMANSHIP
- WIRELESS ENGINEERING
- EXAMINATION (state which)

Name..... Age.....

Address.....



# New Apparatus Reviewed

## LYONS-HICKOK VOLT-OHMS-MILLIAMMETER

THIS is a self-contained versatile measuring instrument of sturdy construction and suitable both for serviceman's and experimenter's use. By means of a switch and a series of socket connectors it provides no fewer than seventeen different ranges, five of which are for AC voltage measurements, while the remainder serve for DC voltage, current, and resistance measurements. In addition, the AC voltage ranges could be employed for power output measurements.

The nucleus of the instrument is a large high-grade moving-coil milliammeter fitted with a dial on which is engraved 3in. long scales.



Lyons-Hickok multi-range testing and measuring instrument.

Used as a voltmeter, the instrument has a resistance of 1,000 ohms per volt on all ranges, and so consumes only one milliampere for a full-scale deflection. AC and DC voltage ranges are the same, viz., 0-10, 0-50, 0-250, 0-500, and 0-1,000 in each case.

The normal current ranges are for full-scale deflections of 0-10, 0-50, and 0-250 mA., but it is possible to use the 0-10 DC voltage range for measuring currents of less than one milliamp. with high accuracy.

The ohmmeter scale is calibrated from 0-10,000 ohms, but it can be extended by two built-in multipliers to measure up to two megohms, though on the highest range an external battery of 67½ volts is needed, for which two terminals are provided just above the meter.

The instrument has been checked against standard laboratory meters, and no fault can be found with its calibration, for all measurements made with the Hickok model agree to within one per cent. of those made with other meters.

Owing to the large number of scales provided, all readings can be made with a high degree of accuracy, and this is greatly assisted by the thin knife-edge pointer fitted. The meter is very well damped, and "snap" readings are easily obtained, since the pointer comes to rest immediately.

A zero adjuster is provided for the pointer, and it should be mentioned that a control marked "Battery" is fitted for setting the pointer correctly for resistance

measurements. This must be adjusted on each of the three resistance ranges if accurate readings are to be obtained, since separate batteries (two are in the unit) are employed.

It is an accurate and most serviceable instrument, and is obtainable from Claude Lyons, Ltd., 40, Buckingham Gate, London, S.W.1, the price being £10 10s.

## EDDYSTONE BANDSPREAD TUNING OUTFIT

THIS short-wave tuning outfit consists of two variable condensers, one being of the order of 150 m-mfds. and the other approximately one-tenth the capacity. The larger model, which is described as the tank condenser, is fitted with a special control that enables its capacity to be changed in steps, each movement of the knob being equal to approximately one-tenth its total capacity.

They are joined in parallel across the tuning coil, and the capacities are so nicely judged that the vernier, or bandspread unit, gives an overlap on each of the ten positions of the tank condenser.

Short-wave listeners, being familiar with the normal criticality of tuning on these high frequencies, will readily appreciate the advantages of the system, as it is often the practice to employ two ordinary condensers to serve the purpose, though it is not always possible to make an accurate calibration of the bandspread condenser, owing to the uncertainty of repeating the setting of the main condenser.

With the positions for the tank condenser definitely fixed, in this case by a ball engaging with holes in a circular plate, calibrating the bandspread member accurately is quite possible.

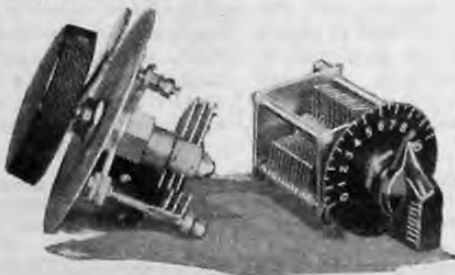

Eddystone short-wave bandspread tuning outfit.

The tank condenser is fitted with a pointer-type knob and a dial plate with ten numbered divisions, while the bandspread member has a 3in. dial with a 0-100 graduated scale. Embodied in its construction is a slow-motion drive giving a reduction of approximately 8½ to 1.

The measured capacity of the tank model is 171 m-mfds. at maximum, i.e., No. 10 position, and 23 m-mfds. at minimum, i.e., at 0 on the scale. Each of the ten divisions represents an increase in capacity of 15 m-mfds.

The bandspread unit tested had measured capacities of 7.5 m-mfds. at minimum and 26 m-mfds. at maximum, so that the effective change is 18.5 m-mfds., thus giving an adequate overlap between the steps on the tank model.

Both condensers are made from brass throughout, and the complete outfit as

## Recent Products of the Manufacturers

illustrated costs 12s. 6d. They can be purchased separately, the prices being 6s. for the tank condenser and 6s. 6d. for the bandspread unit. The makers are Stratton and Co., Ltd., Eddystone Works, Bromsgrove Street, Birmingham, 5.

## RAYMART NEW COIL FORMERS

THE Radio Mart, 44, Holloway Head, Birmingham, 1, has now introduced a new ribbed coil former of the plug-in variety to replace the earlier type, the latest pattern being moulded from a higher-grade material and having lower dielectric losses on the short waves.



They are available fitted either with four, six or seven pins, or with plain or threaded ribs for a spaced winding of sixteen turns per inch. The prices are the same as for the earlier type, viz., 1s. 6d. with four-pin base and 1s. 9d. with six-pin base and plain ribs. The threaded-ribbed models cost 2d. extra.

## Recent H.M.V. Products

TWO new receivers are announced by the Gramophone Co., Ltd. The Model 425 is a simplified version of the Model 445 without the station selector device and is a table model superhet priced at 11 gns. The other new model is a radiogram incorporating the Model 480 all-wave chassis. The specification includes an automatic record changer and wide-range pick-up. The price of the radiogram (Model 485) is 36 gns.

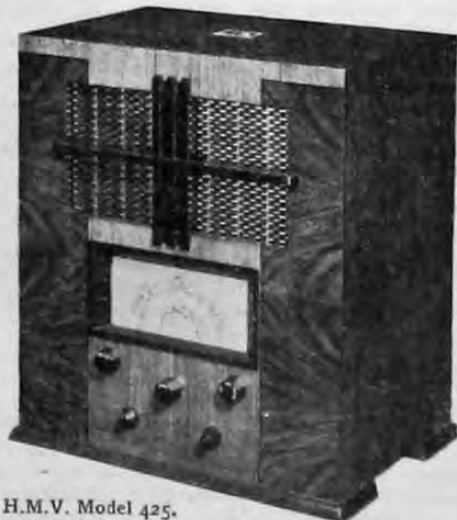

H.M.V. Model 425.



# New Apparatus Reviewed

## GLIMM VOLTMETER

THIS is quite a novel type of voltmeter, as it does not include any moving parts, voltage being indicated by a glow in a small neon tube. It can be used on either AC or DC supplies, and will answer as an indicator for direct or alternating current by the position of the glow about the electrodes. On DC the glow is confined to one electrode only, whereas on AC it is equally distributed about both.



Neon-type voltmeter for AC and DC measurements.

The meter is provided with a knob and scale calibrated from 100 to 440 volts. Having joined the instrument across the points where a measurement is required, the knob is adjusted so that a faint glow just appears between the two electrodes. The voltage is then read off the scale. It is surprisingly accurate for a neon device, and its measurements agree very well with those made with other instruments.

Its most useful feature is that current consumption is practically nil; for example, at 500 volts it passes less than 0.05 mA.

It is obtainable from Eugen J. Forbat, 28-29, Southampton Street, Strand, London, W.C.2, and the price is 27s. 6d.

## L.T.P. OUTPUT TRANSFORMER

THE transformer illustrated is one of the new range now being made by London Transformer Products, Ltd., L.T.P. Works, Cobbold Road, Willesden, London, N.W.10.

This particular model provides two ratios, viz., 22½ to 1 and 15 to 1, and is designed

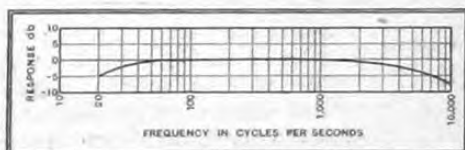

Response curve of the L.T.P. two-ratio output transformer.

to carry DC currents up to 90 mA., and is suitable for use with power valves giving up to about 10 watts AC output.

The windings are sectionalised to keep the

## Recent Products of the Manufacturers

leakage inductance small, and to render it suitable for tropical use it is thoroughly impregnated.

Our measurements give the primary inductance as 35 henrys without DC flowing, 29 henrys with 40 mA., 24 with 60 mA., and 20 henrys with 90 mA. The resistance of the primary is 270 ohms.

The response characteristic was taken following a valve requiring a load of 4,000 ohms and the 15 to 1 ratio was employed with a suitable resistance joined across the secondary. The curve obtained with this combination is given in the accompanying graph. It is quite satisfactory, as the response is virtually constant over the major part of the audible scale.

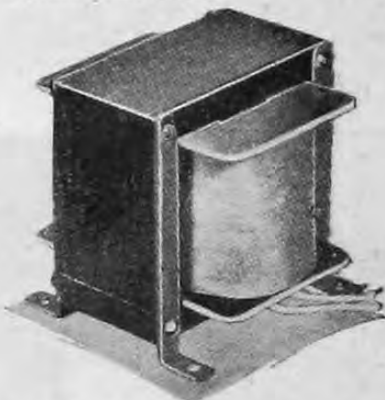

Manufacturers' type two-ratio output transformer made by London Transformer Products.

As a skeleton, or manufacturers' type, the price is 24s. 6d., but the transformer can be obtained in a more attractively finished form with shrouded windings and terminals for an additional 4s.

## EDDYSTONE ALL-WORLD-TWO RECEIVER

THIS new Eddystone receiver is a compact two-valve model designed expressly for short-wave reception. It is supplied as a kit of parts, but the assembly is perfectly straightforward, the layout being very well planned so that all components are readily accessible.

An HF pentode is used for the detector, and this is resistance-capacity coupled to a small power output valve, for, as a rule, headphones only will be used with this set. Either a triode or a pentode can be used in the output position, and a choice of valves is given in the instructional booklet. These have been chosen with a view to economy in operation, and by adopting the maker's recommendations the total HT



Eddystone All-World-Two receiver assembled from the kit of parts.

consumption can be kept within 5 mA. with a 120-volt battery.

Reaction is obtained by capacity-feedback through a reaction coil, but control of detector oscillation is effected by varying the screen voltage.

This arrangement is very satisfactory in practice, for the smoothness of the regeneration is one of the outstanding features of this receiver.

The Eddystone band-spread tuning system is employed, the small band-spread condenser, which has about 20 m-mfds capacity, being mounted in the centre and fitted with a neatly engraved scale, while the "tank" unit is located on the left and below the chassis.

The drive reduction ratio of the band-spread unit is about 8½ to 1, but this is quite slow enough in view of its small capacity.

Standard six-pin plug-in coils are used, and with the Eddystone Type 6LB size the waverange covered was found to be 15.75 to 29.6 metres. At the bottom end of this band the band-spread condenser gave a coverage of two metres, whilst at the top it was reduced to just over one metre.

The band-spread system is a great help, for, despite the small capacity of this condenser, some care is needed in tuning, especially at the lower end of the Type 6LB coil.

The next size coil, Type 6Y, overlapped the other one amply sufficient to take care of variation in stray capacities in different sets, its range being 27.3 metres to 54 metres.

The sensitivity of this set is exceptionally good, so also is the selectivity, for it is possible to receive DJN Zeesen, 31.45 metres, clear of its companion transmitter DJA on 31.38 metres, with one an R8 signal, and yet leave a clear space between them. For a simple detector-LF set this is very satisfactory.

European and American short-wave stations were received well during the time the set was on test, though conditions must be favourable for good reception of the latter.

To sum up, the All-World-Two is a soundly designed and very efficient detector-LF set, and as it is so easy to operate it is ideal for the beginner, yet it forms a valuable stand-by for the more experienced short-wave experimenter.

The price of the complete kit is £3 7s. 6d., and the valves cost 20s. 6d. extra. The makers are Stratton & Co., Ltd., Bromsgrove Street, Birmingham, 5.



# ENJOY SHORTWAVES at CHRISTMAS

You can get first-class headphones reception of World-wide shortwave broadcast and experimental amateur transmissions with this Eddystone battery operated "All-World Two." It will consistently receive many American, European, Australian and other long distance shortwave stations at good volume and quality. It is fitted with special "Eddystone" bandspread tuning. Wave range 15 to 52 metres. Price, with valves and coils, guaranteed aerial tested and ready for immediate use.

**£3.17.6**

Send for full details

## EDDYSTONE ALL-WORLD TWO

STRATTON & CO., LTD., Eddystone Works, Bromsgrove St., Birmingham.  
LONDON SERVICE: WEBB'S RADIO STORES, 14, SOHO ST., OXFORD ST., W.1



### METERS, ETC.

**FERRANTI** Meters, 100 only, triple range, 200 c.p.h.; to clear, 14/- each.—Farnell, 12, Heaton Park Rd., Bradford. [5616]  
**WESTON**, Avo, Hunts, Wearite and other testing instruments.—Wholesale Distributors, Leonard Heys, 36, Henry St., Blackpool. [0568]  
**E.M.I.** Oscillator, £7; Avometer, £13 model, £9, with leather sling case; Weston 0-1 m/a, rectifier type, as new 30/-; Ferranti ditto, 30/-—451, Seven Sisters Rd., N.15. [5664]  
**NEW** Superior O.S.10 Oscilloscope, with spare C.R. tube, £7; Superior V.45 Universal valve tester, with good-bad meter, £5; G.E.C. Type II A.C. power amplifier, 50 watts, with valves, £6.—Harris, Hilltop, Caterham, Surrey. [5677]  
**FERRANTI**, boxed, guaranteed brand new condition, 23-range A.C./D.C. Tester, in case, £3/15; 0-1 m.a. A.C. (rectifier), £2/5; 0-1 m.a., £1/10; 0-100 micro A., £2/7/6; 0-500 micro A., £1/15; rectifier, 2.5, 25, 250v., 2,000 c.p.v., £3/7/6; several M.I.; wanted, resistance bridge.—Box 4260, c/o The Wireless World. [5679]

### TESTING EQUIPMENT

**PAUL** Decade Bridge Containing Galvo, 0.01 to 1,111,000 ohms, £7; Cambridge Unipivot, 5in. scale, 0-60 microamps, £3.  
**REID** Resistance Box, 0-8,000 ohm, £1; Ferranti multi-range D.C. test set, £5; Avo Universal Minor, £3.—Evensden-Jones, 33, Stormont Rd., S.W.11. [5689]  
**E.M.I.** Service Oscillator, with manual; £6/10.—Smith, 920, Maryhill Rd., Glasgow, N.W. [5700]

### NEW COMPONENTS

**IDEAL** Xmas Presents; model electric train transformer units and mains transformers; exceptional prices and quality; write now for lists.  
**A.M.S.**, 28, North Road, Burnt Oak, Edgware, Middlesex. [5569]  
**VIBRATORS** for High Tension, from 2 volts I.T., guaranteed, 12/6 post free, with instructions to build unit.—Simmonds Bros., Rabone Lane, Smethwick. [5685]  
**CONDENSERS**, British manufacture, fixed paper in metal cases: 800 volt working, 4 mfd. 3/9, 2 mfd. 2/3, 1 mfd. 1/6; 500 volt working, 4 mfd. 2/6, 2 mfd. 1/6, 1 mfd. 1/-; 400 volt working, 4 mfd. 1/6, 2 mfd. 1/-, 1 mfd. 8d.; electrolytics, dry, 500 p.v.v., 4 mfd. 1/6, 8 mfd. 1/9, 8+4 mfd. 2/6, 8+8 mfd. 3/-, 16 mfd. 3/-, 32 mfd. 5/-; postage 6d., or c.o.d.—Mentone Radio Stores, 364, Fulham Rd., London, S.W.10. [5678]

### COMPONENTS

**SECOND-HAND, CLEARANCE, SURPLUS, ETC.**  
**R.**  
**RADIO CLEARANCE.**  
**ALL** Lines Previously Advertised Still Available.  
**RADIO CLEARANCE**, 63, High Holborn, W.C.1. Holborn 4631. [5716]  
**VAUXHALL.**  
**VAUXHALL**—Polar midjet condensers, 2-gang 6/8, 3-gang 8/9, 4-gang 13/6; Polar full vision horizontal drives, 5/-.  
**VAUXHALL**—Hivac valves, entire range, full discounts; Polar station named scales for horizontal drives, 1/-.  
**VAUXHALL**—Iron-cored coils, on base with switch, terminals, circuits, 2-gang 11/3, 3-gang 17/-.  
**VAUXHALL**—Clix valveholders, terminals, 5-pin 7d., 7-pin 9d.; soldering, 5-pin 5d., 7-pin 6d.; baseboard, 4-5-pin 6d.  
**VAUXHALL**—Set manufacturers' surplus skeleton type Westinghouse rectifiers; H.T.8 8/6, H.T.9 9/-, H.T.10 10/-; fixing brackets free.  
**VAUXHALL**—Flat sheet aluminium, hard rolled, 18 gauge, 12in. x 12in., 3/-; 18 x 18, 5/6; other sizes pro rata.  
**VAUXHALL**—Resistances by well-known manufacturers, 1-watt type; 6d. each, all values.  
**VAUXHALL**—Volume controls, Erie, Solvern, Centralab, 2/-; with switch, 3/-; all values, from 2,000 to 2 meg.  
**VAUXHALL**—Condensers, 1,000v. working, 8 mfd. 16/-; 1 mfd., 3/6; 0.1 mfd., 2/10; Westectors, W.X.6, 4/-.  
**VAUXHALL**—Post paid 2/6 or over, or cash on delivery, 5/- minimum.  
**VAUXHALL UTILITIES**, 163a, Strand, W.C.2, over Dennys, the Booksellers, Temple Bar 9338. Send postcard for lists, free. [5711]

**PREMIER SUPPLY STORES.**  
**PLEASE** See Our Displayed Advertisement on page 12. [0488]  
**50** Assorted First Grade Resistors; 8/6.  
**50** Assorted Tubular Condensers, all sizes; 8/6.  
**7/6**—Cathode Ray tuning unit, complete with tube.  
**5/11**—Signal keys, genuine American Franklin.  
**8/6**—Power transformers, 110-250 volts, 6.3 at 2.5 amps., 5v. at 2 amps., 350-0-350 at 100 m.a.  
**ALL** Above Goods Brand New and Guaranteed.  
**LEEDS RADIO**, 66, New Briggate, Leeds. [0573]  
**ALL** Lines Previously Advertised Still Available.—Samsons Radio, 4, Praed St., W.2. [5717]  
**FERRANTI** A.F.5, A.F.6, A.F.7, 10/-; A.F.5, 6/6; A.F.5c, 15/-; B.1 chokes, 7/6; B.2, 10/-; Varley 15H, 300 m.a., 17/6; cash or c.o.d.—Grigg, 70, Peel Rd., Wealdstone, Middlesex. [5698]

### 9-VALVE FOUR-WAVE DE LUXE SUPERHET A.C. or A.C./D.C.

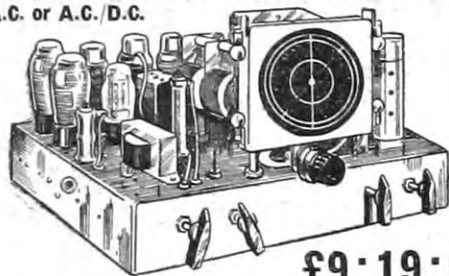

**£9.19.6**

**CIRCUIT**:—Aerial input to Pre-Selector Circuit. Radio frequency amplifier, latest type Triode-Hexode frequency changer, 2-Band-pass I.F.T. coupled to I.F. Amplifiers, Double-Diode Detector, Triode L.F. Amplifier, separate Triode Phase-changer, Capacity coupled to two large high slope Pentodes in Push-Pull A.C. or A.C./D.C. Controls include Variable Sensitivity, Variable Tone on Radio and Gram, Inter-station Noise Suppressor, 5-Position Wave Change and Gram Switch, 12.8 to 2,000 metres. Q.A.V.C., A.V.C. on F.C. 8-watts undistorted output. Complete with 9 B.V.A. Valves. You can purchase these Chassis with full confidence. They are fully guaranteed and will be sent on 7 days' approval against cash with money-back guarantee.

**LIMITED NUMBER—CANNOT BE REPEATED**  
 All chassis are fully tested before despatch.



### SCIENTIFIC ACOUSTIC CORNER HORN

For correct air loading and high quality reproduction.  
 Gives natural balance to the High, Middle and Lower registers.  
 Improves transient response and prevents overloading, stresses and damage to speaker.  
 For all makes of speakers. State inside diameter of cone chassis.

PRICE 35/-

**SCIENTIFIC SUPPLY STORES**  
 33 St. Martin's Court, Charing Cross Rd., W.C.2  
 Next to Leicester Square Station. Phone: RELiance 3097.

### "NOISE IN AUDIO GRID CONTROL CIRCUITS"

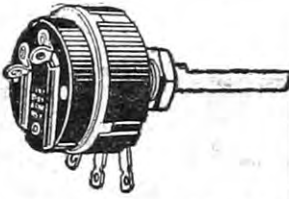

Read this Chapter in the

## NEW Centralab CATALOGUE & GUIDE

It is worth your while to secure this booklet in order that you may read and study the comprehensive article on the above important subject. Centralab enables you to cure those noises which cause listeners so much dissatisfaction. This new Centralab booklet tells you all about Centralab "Radiohms" the World's Finest Volume Controls. There is a "Radiohm" available with or without switch in resistance values from 5,000 ohms to 1 megohm. Write for this new 12 page booklet to-day. It's free.

**LIST PRICE ALL MODELS**  
 Less Switch - - - 3/9 each  
 With Switch - - - 4/6 each

**BRITISH CENTRALAB LTD.**  
 Canterbury Rd., High Rd., Kilburn, London, N.W.6  
 Phone: Malda Vale 6056



**METERS, ETC.**

**WESTON**, Avo Hunts, Wearite, and other testing instruments.—Wholesale Distributors, Leonard Heys, 36, Henry St., Blackpool. [0568]

**TESTING EQUIPMENT**

**A.C./D.C. Avominor**, £3; Avodaptor, 15/-; "Standard" signal generator, £3/10; output meter, £2; "Six-Sixty" set analyser, £2.—Langton, Battersea 6290. [5967]

**SET and Valve Testing Equipment of Mains Oscillator**, valve voltmeter, Megger Standard oscillator, with output meter, Neon output meter, A and E mains isolating unit; offers.—451, Seven Sisters Rd., N.15. [5959]

**NEW COMPONENTS**

**VIBRATORS**, input 2 volts to 6 volts, also complete H.T. units; prices from 12/6; lists free.—Simmonds Bros., Rabone Lane, Smethwick. [5965]

**COMPONENTS**

**SECOND-HAND, CLEARANCE, SURPLUS, ETC.**

**RADIO CLEARANCE.**

**ALL Lines Previously Advertised Still Available.**

**RADIO CLEARANCE**, 63, High Holborn, W.C.1. Holborn 4631. [5978]

**VAUXHALL.**

**VAUXHALL**—T.C.C. electrolytic condensers, 8 mfd. and 4 mfd., 550 volts, 3/-; 500 volts, 2/6.

**VAUXHALL**—T.C.C. condensers, tubular, non-inductive, 0.1, 6d.; 50 mfd., 50v. working, 1/6; 50 mfd., 12v., 1/3; 0.05, 6d.; 0.002, 0.0002, 0.001, 0.0001, 4d. each.

**VAUXHALL**—Iron-cored I.F. transformers, bases, terminals, 110 k/c and 465 k/c; 6/6; guaranteed.

**VAUXHALL**—Collaro A.C. electric motors, boxed, 28/-; similar model, complete pick-up and volume control, 45/6; Universal motors, 52/6.

**VAUXHALL**—J.B. double-ratio drives, 3-band station-named scale, complete, 6/3; De Luxe type, 7/-; standard drive, 2-band, 5/6.

**VAUXHALL**—2-gang 3-range 465 k/c superhet, coils, base, terminals, wavechange switch; 15/3.

**VAUXHALL**—Post paid 2/6 or over, or cash on delivery 5/- minimum.

**VAUXHALL UTILITIES**, 163a, Strand, W.C.2, over Denny's, the Booksellers, Temple Bar 9338. Send postcard for lists free. [5971]

**PREMIER SUPPLY STORES.**

**PLEASE See Our Displayed Advertisement on Page 4.** [0488]

**50 Assorted First Grade Resistors**; 8/6.

**50 Assorted Tubular Condensers**, all sizes; 8/6.

**7/6**—Cathode ray tuning unit, complete with tube.

**5/11**—Signal keys, genuine American Franklin.

**ALL Above Goods Brand New and Guaranteed.**

**LEEDS RADIO**, 66, New Briggate, Leeds. [0573]

**SOUTHERN RADIO'S** Guaranteed Wireless Bargains; post paid.

**PLESSEY** 3-valve Battery Sets, complete in sealed cartons with three Mazda valves, moving coil speaker, Pertrix batteries and accumulator, in exquisite walnut cabinet; 57/6.

**GARRARD** Record Changers, A.C. 200-250 volts, changes eight 10- or 12-inch records; £6 (complete sealed cartons); universal A.C./D.C. model, £7/10.

**GARRARD** A.C. Radiogram Units, with pick-up and all accessories, in sealed cartons; 42/-.

**TELSEN** (1937-38) Components, iron-core coils W.349 (Midget size), 3/6; W.477 (triple ganged for band-pass or straight circuits), 14/6; W.476 (triple ganged superhet), 14/6; W.478 (twin ganged), 9/-; all ganged coils complete on bases, with switch; I.F. transformer coils, 4/6; dual range coils, 2/9; with aerial series condenser, W.76, 3/9.

**TELSEN** A.C./D.C. Multimeters, 5-range (tests anything radio or electrical), 8/6; loudspeaker units, 2/8. Ace (P.O.) microphones, complete with transformer ready for use with any receiver, 4/6; headphones, 4,000 ohms, 3/- pair.

**VALVES**—Full range for American receivers, 6/- each.

**MORSE** Tappers, complete radio-telegraph set (flasher, buzzer and tapper), with batteries, bulb, code, 3/-.

**BARGAIN** Parcels of Assorted Components, including coils, resistances, condensers, chokes, wire, circuits, etc., value 21/-; 5/- per parcel.

**SOUTHERN RADIO**, 323, Euston Rd., London, N.W.1; and 46, Lisle St., London, W.C.1. All mail orders to

**SOUTHERN RADIO**, 323, Euston Rd., London, N.W.1 (near Warren St. Tube). Phone: Euston 3775. [5981]

**FERRANTI** Transformers, Quality Senior speakers, components.—Jefferies, Park House, Watlington, Rhondda, Glam. [5932]

**RYALL'S RADIO**, 280, High Holborn, London, W.C.1.—All lines previously advertised (except sets, none available) can still be supplied. [5883]

**FERRANTI** 0-100 Microamps., £2/5; 0-500 microamps., £1/15; 0-1 m.a., £1/10; cash or c.o.d.—Grigg, 70, Peel Rd., Wealdstone, Middlesex. [5963]

**FOR EVERYONE INTERESTED in SHORTWAVES**



You can get first-class headphones reception of World-wide shortwave broadcast and experimental amateur transmissions with this Eddystone battery operated "All World Two." It will consistently receive many American, European, Australian, and other long distance shortwave stations at good volume and quality. It is fitted with special "Eddystone" bandspread tuning. Wave range 15.5 to 52 metres. Price, with valves and coils, guaranteed aerial tested and ready for immediate use.

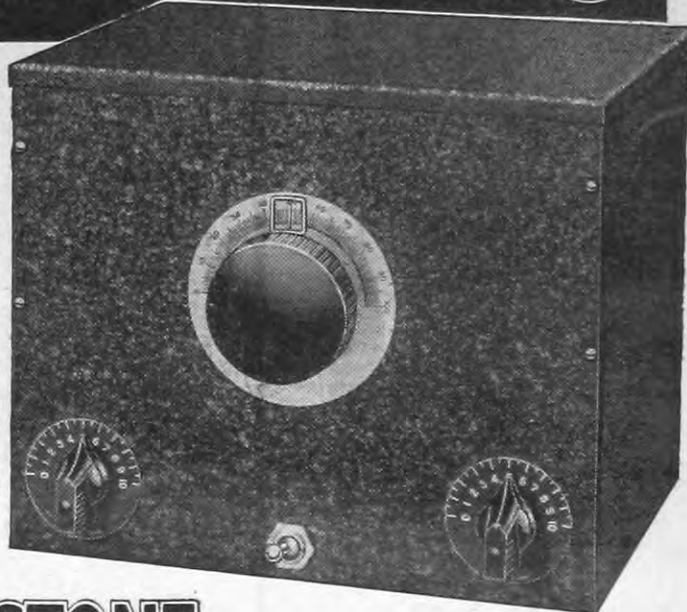

**£3.17.6**

Send for full details

**EDDYSTONE ALL-WORLD TWO**

STRATTON & CO., LTD., Eddystone Works, Bromsgrove St., Birmingham. LONDON SERVICE: WEBB'S RADIO STORES, 14, SOHO ST., OXFORD ST., W.1



Archimedes-like, Brown cries "Eureka!" So that's why my set is a squeaker. I'll get some FLUXITE. And this very same night Recreate it, into a LOUD speaker!"

See that **FLUXITE** is always by you—in the house—garage—workshop—wherever speedy soldering is needed. Used for 30 years in Government works and by leading engineers and manufacturers of Ironmongers—in tins, 4d., 8d., 1/4 and 2/8. Ask to see the **FLUXITE SMALL-SPACE SOLDERING SET**—compact but substantial—Complete with full instructions, 7/6. Write for Free Book on the art of "SOFT" SOLDERING—and ask for leaflet on **CASE-HARDENING STEEL and TEMPERING TOOLS with FLUXITE.**

**TO CYCLISTS!** Your wheels will NOT keep round and true unless the spokes are tied with fine wire at the crossings AND SOLDERED. This makes a much stronger wheel. It's simple—with **FLUXITE**—but IMPORTANT

**THE FLUXITE GUN**

is always ready to put Fluxite on the soldering job instantly. A little pressure places the right quantity on the right spot and one charging lasts for ages. Price 1/6.



ALL MECHANICS WILL HAVE

**FLUXITE**

IT SIMPLIFIES ALL SOLDERING

FLUXITE LTD., Dept. W.W. DRAGON WORKS, BERMONDSEY ST., S.E.1



Noted the world over as suppliers of Quality Radio... specially catering for "Wireless World" readers with a staff of trained technicians and engineers for dealing with this special class of apparatus.

Wave ranges:  
10-25 metres  
25-65 "  
200-550 "  
800-2000 "

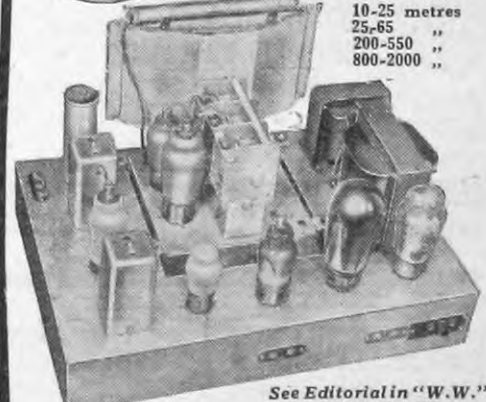

See Editorial in "W.W." dated 20/1/38

**"W.W." FOUR-BAND SUPER SIX (B.T.S. VERSION)**

Complete Chassis constructed exactly to designers' circuit with B.T.S. 4-band Tuner with plate-glass station-named dial, B.T.S. specified chassis. Complete with 6 matched valves, knobs and catchecoon. £16:16:0 Aerial tested on all wavebands before despatch

H.P. Terms available on request. B.T.S. High Fidelity Moving Coil Speaker, recommended for use with above... £5:5:0

**B.T.S. 4-BAND TUNER**

for above Receiver. Complete assembled H.F. and Frequency Changer Unit for 4 wavebands as above. B.T.S. rotary switches, screened coils. New type De Luxe dial with double-ratio slow motion drive. Plate glass scale, engraved station names, indirect illumination. Robust steel chassis with anti-vibration lugs. Overall dimensions 9 1/2" x 7" x 10 1/2" to top of scale. Price £5:15:0 Less Valves.

Specified for "W.W." MIDGET QUALITY SET B.T.S. Specified Chassis; supplied complete with component brackets and paxolin sub-panel; drilled exactly to specification, but less valve-holders. Post 9d. extra. B.T.S. Specified Coils; complete set supplied ready-wound exactly to 9/6 designer's specification for wiring straight into circuit. Post 6d. extra.

BRITISH TELEVISION SUPPLIES LTD. (W.W.21)

8/10 Charing Cross Rd., London, W.C.1. Tel.: Temple Bar 0134



# Band-Spread Tuning

By  
H. B. DENT

## SIMPLIFYING THE CONTROL OF SHORT-WAVE RECEIVERS

**O**F the many problems that arise in the designing of a short-wave receiver, few present so much difficulty as the tuning arrangements. It is not the mechanical side of the business that troubles one so much as the electrical, for as the frequencies are so much higher than we have to contend with on the medium broadcast waveband, quite a small variation in the capacity of the tuning condenser results in a comparatively large change in frequency.

*WHY tuning is inherently so much more difficult on short than on medium or long waves is clearly explained in this article. Mechanical and electrical means of overcoming the trouble are described.*

For example, a 0.0005 mfd. (500 m-mfds.) condenser tuning a medium-wave size coil may cover a band of 1,500 to 550 kc/s, 200 to 550 metres, or a change of 950 kc/s. In this ether space can be accommodated about 100 broadcast stations, and if the dial is engraved 0-100 we get approximately one station, or station channel, per division. With a dial of about four inches in diameter the actual movement of the condenser spindle for a dial-change of one division is extremely

room for 950 stations, and with our 0-100 division dial nearly ten stations will be crowded into each division. Obviously, the tuning will be very critical.

Needless to say, the usual practice is to reduce the size of the tuning condenser, and one of about 160 m-mfds. or smaller is generally employed. Even with a condenser of this size we can get a frequency coverage of, for example, from 15,000 kc/s to 7,250 kc/s—20 to 41.5 metres.

In the process we will have somewhat improved the true tuning range as the stray capacities will almost certainly be smaller and the effective capacity change will consequently be relatively larger.

able condenser to 100 m-mfds., fit a really good slow-motion drive and take more care in the tuning.

If one examines the short-wave region it will be seen that there are many areas having no real interest to the average listener, and only quite small bands are occupied by broadcast and amateur stations, the remainder being used by commercial services of one kind or another.

Fig. 3.—In this arrangement the band-spread condenser C2 is connected across a part of the tuning coil.

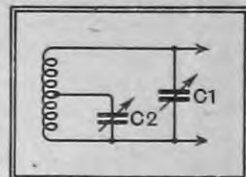

Broadcasting is confined mainly to six well-defined areas, commonly referred to as the 21, 17, 15, 11, 9 and 6 Mc/s bands, while amateurs have use of frequencies in the region of 28, 14, 7 and 3.5 Mc/s, in addition to some frequencies just below the medium broadcast band and comprising 1,715 to 1,925 Mc/s, which in the true sense is hardly a short-wave band.

### Alternative Systems

The question that now arises is how can one cover this enormous band of frequencies with a reasonable number of coils, or ranges, and at the same time make it possible to tune over the useful portions of the band in such a way that stations can be logged on the dial with a reasonable certainty of repetition?

There are two schemes in general use; one is described as mechanical and the other as electrical band-spread. In mechanical band-spread advantage is taken of the slow-motion driving mechanism to provide a vernier or subsidiary pointer having its own scale. If the gear-down ratio is 20 to 1 the driving knob makes ten complete revolutions for one half-revolution of the condenser spindle. Now by having a main pointer travelling over a scale engraved 0-10, as shown in Fig. 1, and arranging for the second pointer to traverse another scale, similarly engraved, the smaller will make one complete revolution for a travel of the larger of from, say, 0 to 1 on the outer scale.

Fig. 2.—Electrical band-spread by means of a parallel-connected condenser.

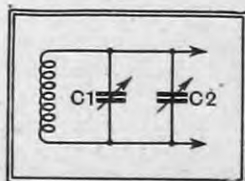

Even this very drastic reduction in the size of the condenser has only lowered the actual band of frequencies covered to 7,750 kc/s, still giving about seven stations, or station channels, of 10 kc/s in each division on the dial. The tuning must inevitably be just seven times more critical than on the medium waveband. In order to achieve the same conditions the frequency band will have to be limited to 950 or, say, 1,000 kc/s, but then the waveband covered by a full rotation of the condenser will be only from 20 to 21.4 metres. Obviously, this is quite impracticable, as, to cover a range of 12.5 to 80 metres only, dozens of coils will have to be used.

On the short wave, therefore, a compromise is necessary. One way out of the difficulty is to reduce the size of the vari-

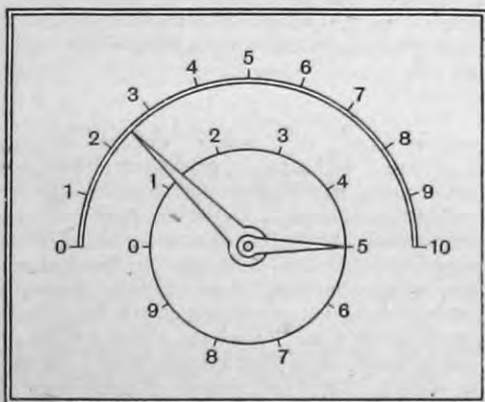

Fig. 1.—Mechanical band-spread: in conjunction with a suitably geared drive, the use of main and subsidiary scales permits the accurate recording of tuning settings.

small, and quite a good slow-motion drive is needed to make the tuning-in of stations reasonably easy.

Let us now examine the conditions obtaining on, say, 20 metres. If we use the same size condenser and merely change the coil it would be possible to cover a band of frequencies of from, say, 15,000 kc/s to 5,500 kc/s. Note that the ratio of the lower to the higher frequency is the same as on the broadcast band previously mentioned, but this now represents a frequency coverage of 9,500 kc/s, giving



Component parts of an electrical band-spread system. The condenser on the left is variable in steps and the intervals are covered by the vernier unit on the right. It is made by Eddystone.

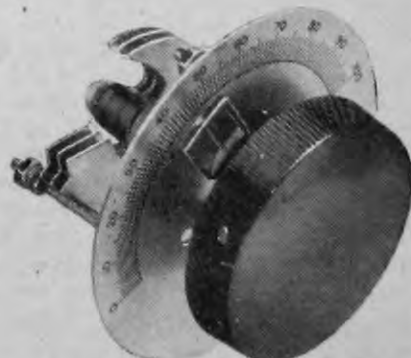



**Appendix 6: Extracts from the *1936-7 Eddystone Component Catalogue***



# For Dependable Service



## BANDSPREAD TUNING OUTFIT

Devised to simplify station selection.

**TANK UNIT.** Cat. No. 1042.  
The tank condenser unit has a capacity range of 10 x 14 mmfd., achieved by a patented step by step device. Complete with scale and knob. Price 6/-

**TRIMMER UNIT.** Cat. No. 1043.  
In parallel with the Tank capacity is the slow motion Bandspread Trimmer condenser, with a capacity slightly greater than each step of the Tank condenser. Complete with dial. Price 6/6

**SLOW MOTION DRIVING HEAD.** Cat. No. 1012.  
Very useful for Transceivers and Ultra Short Wave Receivers. With 9-1 reduction ratio. Price 3/-

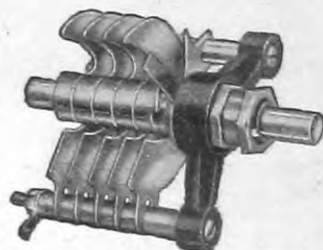

**HIGH-VOLTAGE MICRODENSER.**  
Highly efficient. Soldered brass vanes. Constantly maintained capacity; very low minimum 3 mmfd. DL9 insulation. 1/2 in. spindle extended for ganging. Peak flashover voltage 3,500 volts. Easy to gang—capacity matched within 1 per cent. Cat. No. 1094. 18 mmfd. Price 3/9

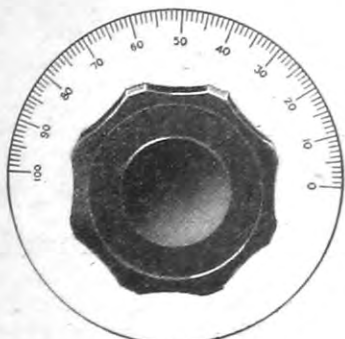

**POPULAR TYPE DIAL.**  
Direct Drive. Cat. No. 1098.  
The 4 in. Scale is satin finish aluminium with clearly marked divisions. It is fitted with a 2 1/2 in. knob for 1/2 in. spindles. Price 4/6



**MINIATURE POPULAR TYPE DIAL.**  
Direct Drive. Cat. No. 1099.  
The 2 1/2 in. Scale is satin finish aluminium with clearly marked divisions. It is fitted with 1 1/2 in. knob for 1/4 in. spindles. Price 2/-



**AIR DIELECTRIC TRIMMER.**  
DL-9 insulation. 3 to 65 mmfd. For all pre-set and trimming purposes and particularly for use with I.F. transformers. Cat. No. 978. Price 3/6



**FLEXIBLE CABLE COUPLER.** Cat. No. 1096.  
For front panel control of awkwardly placed components. Will drive through 90 deg. perfectly. One hole fixing. For 1/2 in. Spindle. Price 3/6

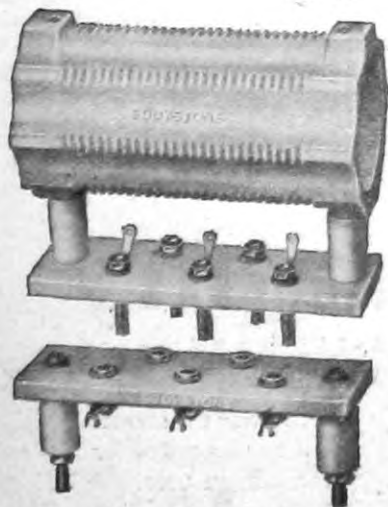

**FREQUENTITE LOW LOSS FORMER.** Cat. No. 1090.  
Ideal for Amateur transmitters. Former size 5 in. x 2 1/2 in., spiral grooves take 26 turns of wire up to 12 gauge. Winding data supplied with former. Price 4/-

**FREQUENTITE SUB-BASE.** Cat. No. 1091.  
For mounting former No. 1090. Can be used as base for self-supporting inductances. Power plugs ensure positive contact. Price 3/6

**FREQUENTITE BASE.** Cat. No. 1092.  
For mounting former with sub-base. Heavy-duty power sockets for sound electrical connection to former. Price 3/9

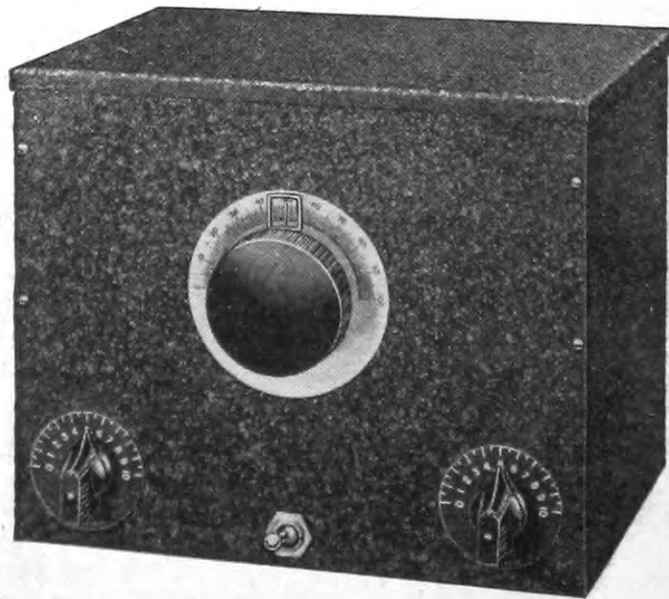

## EDDYSTONE "THE ALL WORLD TWO."

You can get first-class reception of World-wide short-wave broadcast and experimental amateur transmissions on your headphones with this Eddystone battery-operated "All World Two." It will receive consistently American, European, Australian, and other long distance shortwave stations at good volume and quality. It is fitted with "Eddystone" Patent Bandspread tuning. Wave range 15.5 to 52 metres. Price with valves and coils, guaranteed aerial tested and ready for immediate use. £3 17 6

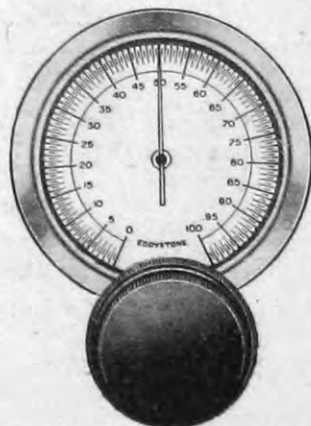

**FULL VISION DUAL SPEED DIAL.** Cat. No. 1070.  
A full vision dual speed dial with 20 : 1 and 100 : 1 speeds. Well graduated scale, reading increasing as frequency increases. For 1/2 in. panel and 1/2 in. spindles. Ideal for H.F. tuning. Price 8/9

# EDDYSTONE

## SHORT WAVE COMPONENTS

SEND FOR 1938 CATALOGUE.

STRATTON & CO., LTD., BROMSGROVE ST., BIRMINGHAM  
London Service: Webbs Radio, 14, Soho Street, Oxford Street, London, W.1.





# Components of Merit



**ALUMINIUM VALVE SHIELD.**

For octal valves. Fits No. 1120 Eddystone valveholder. No. 1121 .. 1/3d.



**FLEXIBLE DRIVING SHAFT.**

For front panel control of awkwardly placed components. Drives through 90 degrees perfectly. Cable length 5 3/8 in. No. 1096 .. 3/6d.



**INSULATED BRACKET**

DL9 insulation and brass base. Fixing centre, height 1 1/8 in. No. 1116 .. 1/3d.

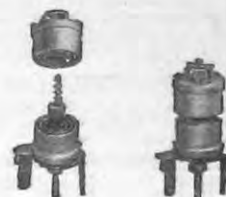

**S.W. AIR TRIMMER.**

A compact trimmer condenser with capacity variation of 1-30 mmfd. Finely graded control and constant setting. No. 1100, 1/3d.



**DIECAST ALUMINIUM CHASSIS.**

Strong and rigid construction. Measures 8 1/2 in. x 5 3/8 in. x 2 3/8 in. deep. Two terminal panels provided. No. 1117 .. 5/6d. Undrilled metal panel, No. 1118 1/9d.

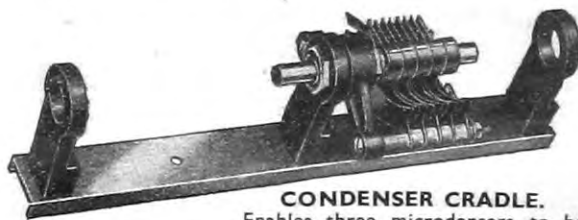

**CONDENSER CRADLE.**

Enables three microcondensers to be mounted as three gang condenser unit. Rotors and stators completely isolated. Brass division plates available for screening condenser units. No. 1114, 3/6d. Metal screens, No. 1125, 8d. pair.



**BEAT FREQUENCY OSCILLATOR UNIT.**

For 450/470 Kc/s. Aluminium can measures 2 1/8 in. high by 1 3/8 in. square. For use with 6J7 valve. No. 1119 .. 8/6d.

Write for illustrated 1939 Catalogue—  
Free on request.

## EDDYSTONE

Sole Manufacturers: *Stratton & Co. Ltd.*  
*Bromsgrove St., Birmingham.*  
London Service: *Webbs, 14 Soho St., W.1*

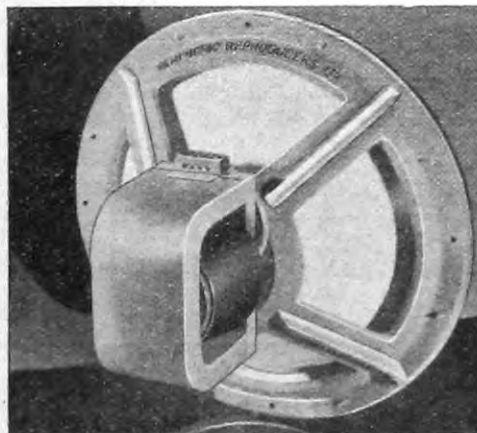

## Speaker for the MAN who KNOWS

Exceptional strength of magnetic flux ensures complete freedom from "Boom" in bass. Extreme sensitivity, in direct comparison, 4 db. up on other speakers. Response curve shows maintained response level well into region of 10,000 c.p.s.

**TELEFUNKEN PICK-UP "TO-1001."**



Permanent sapphire needle. Level response from 40 to 10,000 cycles. Weight of pick-up on record less than 1oz. Price **£5.5.0**  
Matching transformer, **£1.6.0**.  
Tone control unit, incorporating transformer, **£4.4.0**

**SPEECH COIL IMPEDANCE** 10 ohms @ 400 c.p.s.  
**SPEECH COIL DIAMETER** - 2 inches.  
**SPEECH COIL TOTAL GAP CLEARANCE** - - - - - 0.016 inch.  
**SPEECH COIL POWER HANDLING CAPACITY** 20 watts, average.  
**MAGNETIC FLUX DENSITY** 17,000 lines/sq. cm.  
**TOTAL MAGNETIC FLUX** - 260,000 lines.  
**FIELD COIL DISSIPATION** - 40 watts.  
**DIAMETER OF DIAPHRAGM** 16 inches  
**TOTAL WEIGHT OF SPEAKER** - - - - - 44 lbs.  
**FINISH** : Cadmium plate and grey cellulose.  
**PRICES** : Unit only, **£8.14.0**.  
Rectifier Unit for 200-250 v. A.C. Mains, **£2.12.6**.



**20,000 ohms per volt.**

The **HIGH RESISTANCE Avo MINOR**

*Regd. Trade Mark*  
ELECTRICAL MEASURING INSTRUMENT

**CURRENT**  
0- 50 microamps  
0-250 microamps

**VOLTAGE**  
0- 2.5 volts      0- 10 volts  
0- 50 volts      0- 100 volts  
0-250 volts      0-1000 volts

**RESISTANCE**  
0- 5 megohms (with 10 V applied)  
0-50 megohms (with 100 V applied)

*(Adjustment provided for incorrect voltage)*

Complete in case with special high-voltage leads, interchangeable crocodile clips and testing prods; and instruction booklet ... **£3:10s.**

Deferred Terms if desired.

BRITISH MADE.  
Sole Proprietors and Manufacturers:  
**The AUTOMATIC COIL WINDER & ELECTRICAL EQUIPMENT CO., LTD.**  
Winder House, Douglas Street, London, S.W.1.  
Phone: Victoria 3404-7.

WRITE FOR FULL DETAILS.

# Pamphonic

(Associated with P.Y.E., Ltd.)  
**Reproducers Limited**  
45, ST. PANCRAS WAY, LONDON, N.W.1. (Phone: EUSton 1727.)

Mention of "The Wireless World," when writing to advertisers, will ensure prompt attention.



9 METRES

2,000 METRES

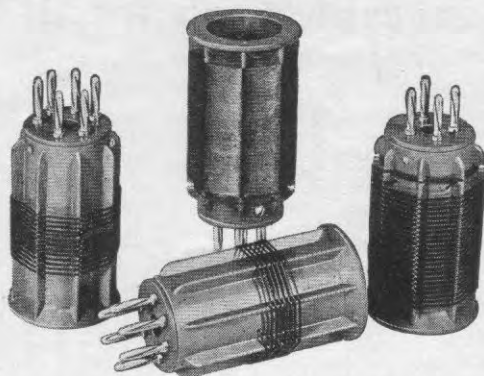

## Interchangeable Coils for all Waves.

D.L.-9. LOW LOSS DIELECTRIC.

These Coils employ formers made from the new low loss dielectric D.L.-9, a dielectric far superior to bakelite for high frequency use. A complete range is available with 4-pin and 6-pin bases, having two and three windings respectively. The short wave coils are space wound with 22 gauge enamelled copper wire on threaded formers, the higher wave coils being single layer wound with enamelled wire except the long wave coil, which consists of a number of windings in a slotted former. The form shape is such that the coils are highly efficient and also mechanically strong in construction. The range of coils is designed so that 4-pin and 6-pin coils can be used in the same circuit. All wave ranges given are with a .00016 mfd. condenser and are approximate figures allowing for circuit load.

6-Pin Type.				Cat. No. 959.			
Type	Metres	Code	PRICE	Type	Metres	Code	PRICE
Type 6BB	9-14	EXBB	3/3	Type 6P	150-325	EXPI	4/6
Type 6LB	12-26	EXLIB	3/3	Type 6G	260-510	EXGO	4/6
Type 6Y	22-47	EXYEL	3/3	Type 6BR	490-1000	EXBRO	5/-
Type 6R	41-94	EXRE	3/3	Type 6GY	1000-2000	EXDOY	5/-
Type 6W	76-170	EXWO	3/9				

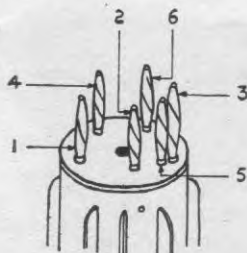

DIAGRAM 1—  
Pin connections for 6-pin  
coil base.

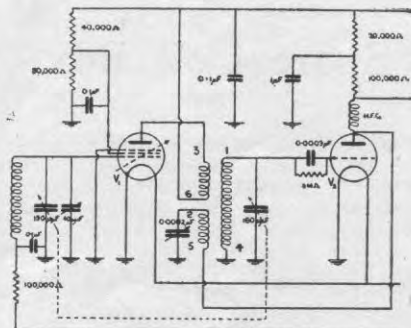

DIAGRAM 2—Tuned H.F. stage using 6-pin coil as H.F. transformer, aperiodic primary, tuned secondary with reaction.







## Split Stator Condenser

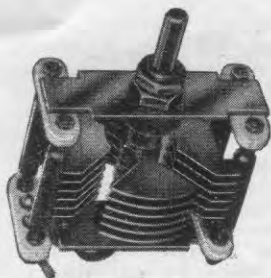

CAT. No. 1068.

Code STATR.

Price .. **12/6.**

The Split Stator Condenser will find many uses as the tuning element in short wave receivers, transmitters or wavemeters. It provides the choice of three different maximum capacities according to the way in which it is used. It is a solidly built component with heavy brass vanes with polished edges. All metallic connections are soldered to ensure minimum losses and a low high frequency resistance. Both sets of fixed vanes are supported on Frequentite Insulators while the back bearing of the rotor is insulated from the brass cross-member, the connection being made to it by a screened non-inductive pigtail. It is quite noiseless in use.

Minimum capacity formed by rotor, and one side is 5 m.mfd. and the maximum capacity 40 m.mfd. With the two sides in parallel, the minimum is 10 m.mfd. maximum 80 m.mfd. When used as a series-gap condenser minimum capacity is 3 m.mfd. and the maximum 20 m.mfd.

## Bandspread Tuning Outfit

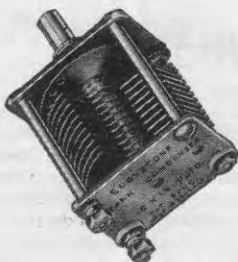

PAT. PENDING.

Tank Unit. No. 1042. PRICE **6/-.**  
Code TANKT.



The "EDDYSTONE" bandspread method of short wave tuning is devised to simplify station selection. Two Condensers are used, the first or Tank Condenser being a compact Air Dielectric unit having a capacity range of  $10 \times 14$  m.mfd. This is achieved with a patented stop device graduated in 10 steps. Each step covers a capacity of 14 m.mfd., band settings being accurately pre-determined and controlled by a black bakelite switch knob moving over a metal dial plate graduated 0-10.

Parallel with the Tank capacity, the "EDDYSTONE" bandspread slow motion trimmer having 9-1 reduction ratio is used. It has a capacity range slightly greater than each separate step of the Tank Condenser. This enables each 10th section of the whole to be spread over  $180^\circ$ , and provides a tuning ratio of 90-1. It gives a definite advantage in short wave tuning, in that a fairly large movement of the bandspread condenser is necessary to effect small changes in tuning, thus separating stations which with generally accepted tuning circuits appear too close to one another to allow clear

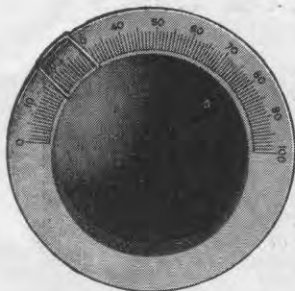

Bandspread Unit. No. 1043. PRICE **6/6.**  
Code TRIMT.

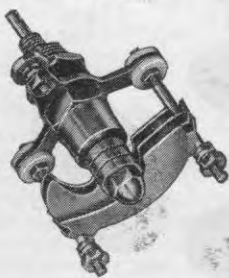

separation. The trimmer is absolutely noiseless in operation and has a smooth positive control action.







## Small Pointer Knob and Dial

A 1½" aluminium dial plate finished black and marked 0-10 in white letters. ¼" or ⅜" hole as desired. Black bakelite pointer knob for ¼" spindle, fluted grip and tapering pointer with engraved white line.

CAT. No. 1044.

Code INDIP.

PRICE 1/-

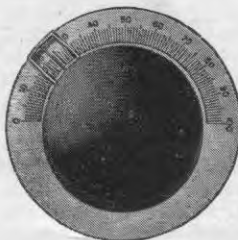

## Knob Dial and Cursor

A handsome direct drive control outfit which can be used with extension spindles and any components employing ¼" spindle. The cursor is shown out of position so that the method of fixing is clear. A 2" black bakelite knob and 3" 100° dial complete the outfit.

CAT. No. 1026.

Code OSKUR.

PRICE 2/-

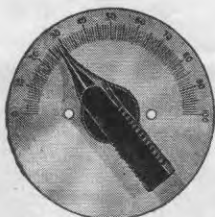

## Pointer Knob and Dial

A straight through control with 3" satin finish aluminium dial, engraved 0-100° in black. The pointer knob is of elegant shape in black bakelite, has fluted grip and tapering pointer with engraved white line. For ¼" spindles only.

CAT No. 1027.

Code OSKO.

PRICE 1/3

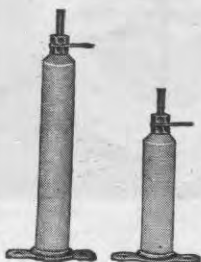

## Insulating Pillars

Most useful for mounting components in ultra short wave receivers. Made in two heights with white D.L.-10 insulating portion 2½" or 1½" long by ⅛" diameter. N.P. metal foot with 2-hole fix and long 6BA screw shank (adjustable) at top.

CAT. No. 1028. 2½" Pillar. Code PILOX. PRICE 6/- doz.

CAT. No. 1029. 1½" Pillar. Code PILAX. PRICE 4/6 ..

## Ultra Short Wave I.F. Unit

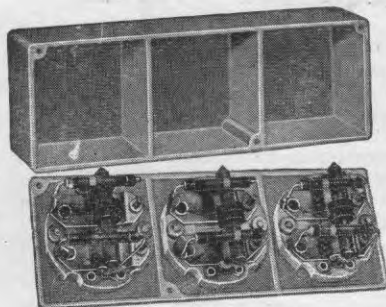

A three unit, two stage I.F. unit working on 2000 kc/s, enclosed in a diecast box giving complete screening to each section, yet a compact total size. The three sections each house a H.F. transformer with tuned windings carefully designed and damped with resistors to give a practical band-width for sound receivers. The anode leads are screened.

CAT. No. 1037. 2000 kc/s.

Code USIF. PRICE 25/6

Size, 6¼" × 2¼" × 1½" deep.

PATENT No. 350188.





## Iron Cored Filament Choke

Iron Cored Filament Choke for use in the filament circuit of battery operated Super-Heterodyne receivers using electron coupled oscillator.

CAT. No. 1062.

Code FILA.

PRICE .. 3/6

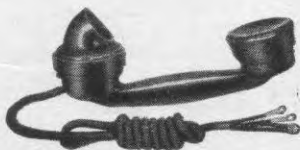
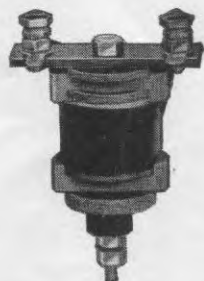

## Hand Microtelephone

P.O. pattern in moulded black bakelite case. Immersed electroed Microphone gives strong and good quality speech. Highly sensitive 1000 ohm earpiece. Very suitable for Ultra Short-wave radio telephones.

CAT. No. 1071. Code MICRA. PRICE 25/-

## Welded Steel Cabinets

The No. 1061 cabinet is rigidly and strongly built in brown crinkle finished steel. It has a hinged lid, and holes in the back allow entry of connecting leads. Size, 8½" wide × 6" deep × 7" high.

CAT. No. 1061. Code STECL. PRICE, 9/6

Plain Undrilled Metal Panel. Extra 1/9

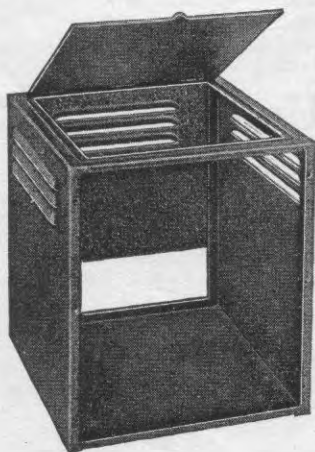
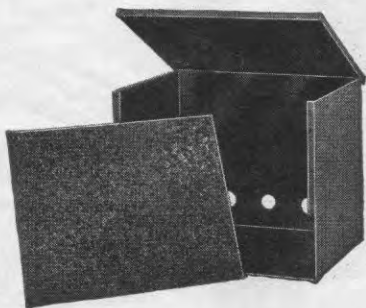

A very smart cabinet for the home constructor, rigidly and strongly built and finished in a bright ripple stoved black finish. The lid is hinged and the cabinet has ventilating louvers at the back and sides. A plain undrilled panel is supplied and the baseboard should be fastened to this, the whole assembly pushing in from the front. A gap in the back of the cabinet allows for connections. Made in two sizes.

CAT. No. 1033. Code STECA. PRICE 12/6

Size, 8½" wide × 9½" back to front × 9¾" high.

CAT. No. 1034. Code STECO. PRICE 18/6

Size, 17" wide × 9½" back to front × 9¾" high.

